

Vehicle Tracking Envelope Index

SED_NO	Title
VT0000	Vehicle Tracking Envelope Index
VT0001	NZTA - 95th - Mobility Scooter
VT0010	AT - Car - 50th
VT0011	AT - Car - 85th
VT0012	AT - Car - 85th - with VLT
VT0013	AT - Car - 85th - with Boat
VT0014	AT - Car - 85th - with Caravan
VT0015	AT - Car - 95th
VT0016	AT - Delivery Van
VT0030	AT - Fire - Aerial Unit
VT0031	AT - Fire - Rotary Ladder Truck - 10.7m
VT0032	AT - Fire - STD Pumper
VT0040	AT - Rubbish - 7.3m - Rear load
VT0041	AT - Rubbish - 8.8m - Front Load - Fixed Rear
VT0042	AT - Rubbish - 8.8m - Side Load - Rear Steer
VT0043	AT - Rubbish - 10.3m
VT0050	AT - Truck - 8.3m Truck
VT0051	AT - Truck - 11.5m Truck
VT0052	AT - Truck - 12.6m Truck
VT0053	AT - Truck - 17.9m Semi (RTS18)
VT0060	AT - Truck - HPMV - 19.45m Semi
VT0061	AT - Truck - HPMV - 22.0m T&T
VT0062	AT - Truck - HPMV - 23.0m T&T
VT0063	AT - Truck - HPMV - 23.0m Car Transporter
VT0070	AT - Special - 22.0m - Fuel Tanker
VT0071	AT - Truck - BP Fuel Tanker (Rear steer)
VT0100	(AT Design Vehicle) - 12.6m Urban Bus (RTS18)
VT0101	(AT Check Vehicle) - 13.5m Urban Bus - Rear Steer
VT0102	AT - Bus - 11.3m Commuter
VT0103	AT - 11.6m Enviro200EV
VT0104	AT - Bus - 12.5m Double Decker - ADL
VT0105	AT - Bus - 12.6m Designline 800
VT0106	AT - Bus - 12.6m Double Decker - Scania
VT0107	AT - Bus - 13.5m Airbus Kiwi - Scania
VT0108	AT - 13.5m Yutong E13 - EV Bus
VT0109	AT - Bus - 14.5m Intercity
VT0110	AT - Bus - 19.0m Articulated

Review

1



DATE: August 8, 2021

TDM TECHNICAL STANDARDS

Vehicle Tracking Envelope Index

Date:

Document in Review

SED No.

VT0000

Version

A

Working Draft - For Review

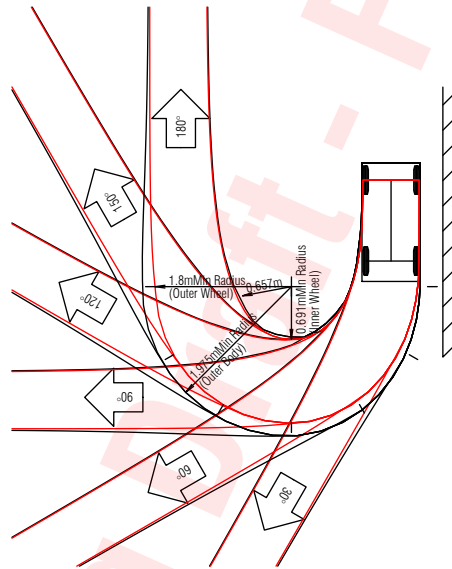

TRACKING VEHICLE

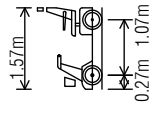

NZTA - 95th - Mobility Scooter

Overall Length	1.570m
Overall Width	0.770m
Overall Body Height	1.245m
Min Body Ground Clearance	0.185m
Max Track Width	0.750m
Lock-to-lock time	2.00s
Curb to Curb Turning Radius	1.800m



A4 1:100	
A3 1:50	

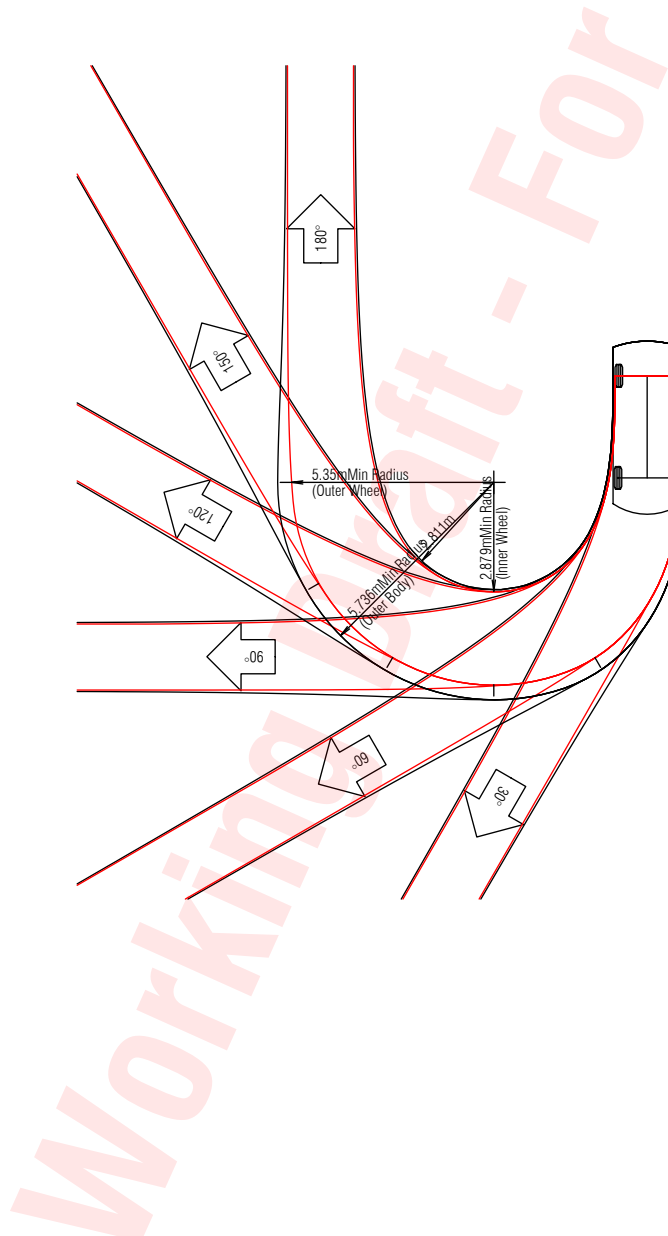

TRACKING VEHICLE

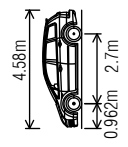

AT - 50th - Car

Overall Length	4.580m
Overall Width	1.805m
Overall Body Height	1.505m
Min Body Ground Clearance	0.150m
Max Track Width	1.746m
Lock-to-lock time	4.00s
Curb to Curb Turning Radius	5.350m

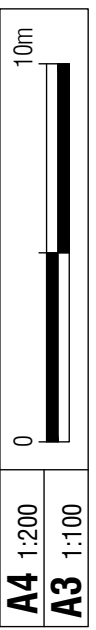

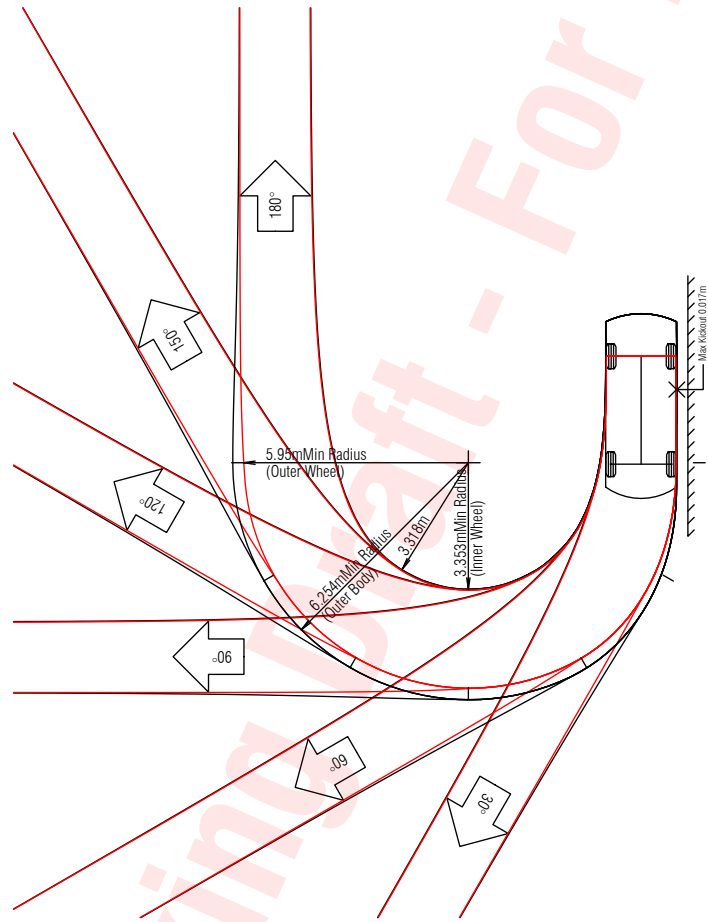

TRACKING VEHICLE

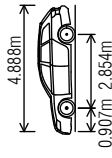

AT - 85th - Car

- Overall Length 4.888m
- Overall Width 1.874m
- Overall Body Height 1.440m
- Min Body Ground Clearance 0.138m
- Max Track Width 1.859m
- Lock-to-lock time 4.00s
- Curb to Curb Turning Radius 5.950m



A4	1:200	
A3	1:100	

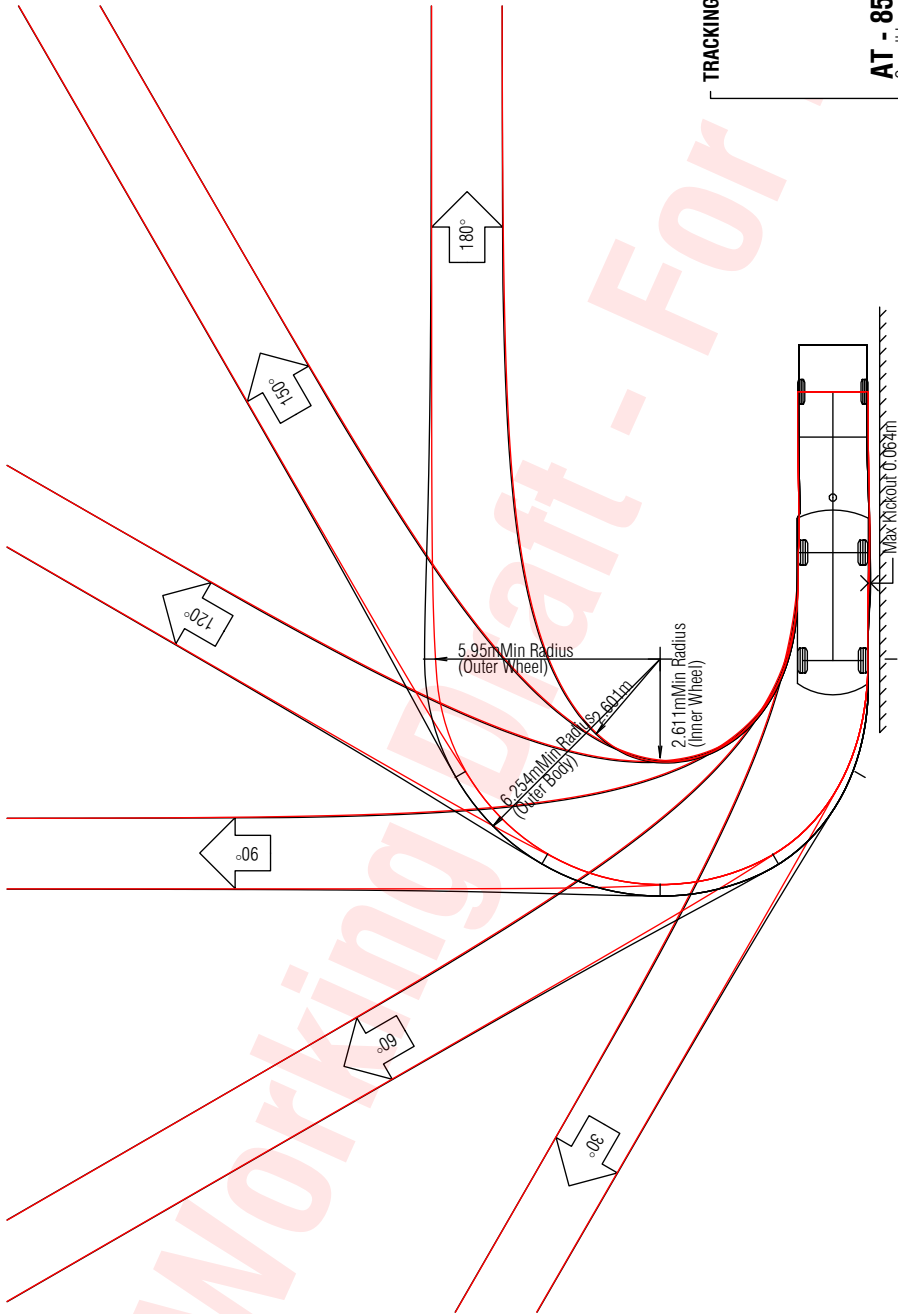

TRACKING VEHICLE

AT - 85th - Car with VLT

Overall Length	9.257m
Overall Width	1.874m
Overall Body Height	1.440m
Min Body Ground Clearance	0.138m
Max Track Width	1.860m
Lock-to-lock time	4.00s
Curb to Curb Turning Radius	5.950m

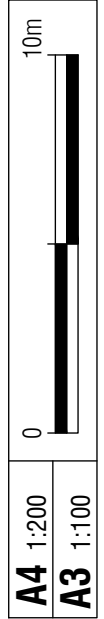

Review 1

DATE: August 8, 2021

TDM TECHNICAL STANDARDS

AT - Car - 85th - with VLT

Date: **Document in Review**

SED No. **VT0012** Version **A**

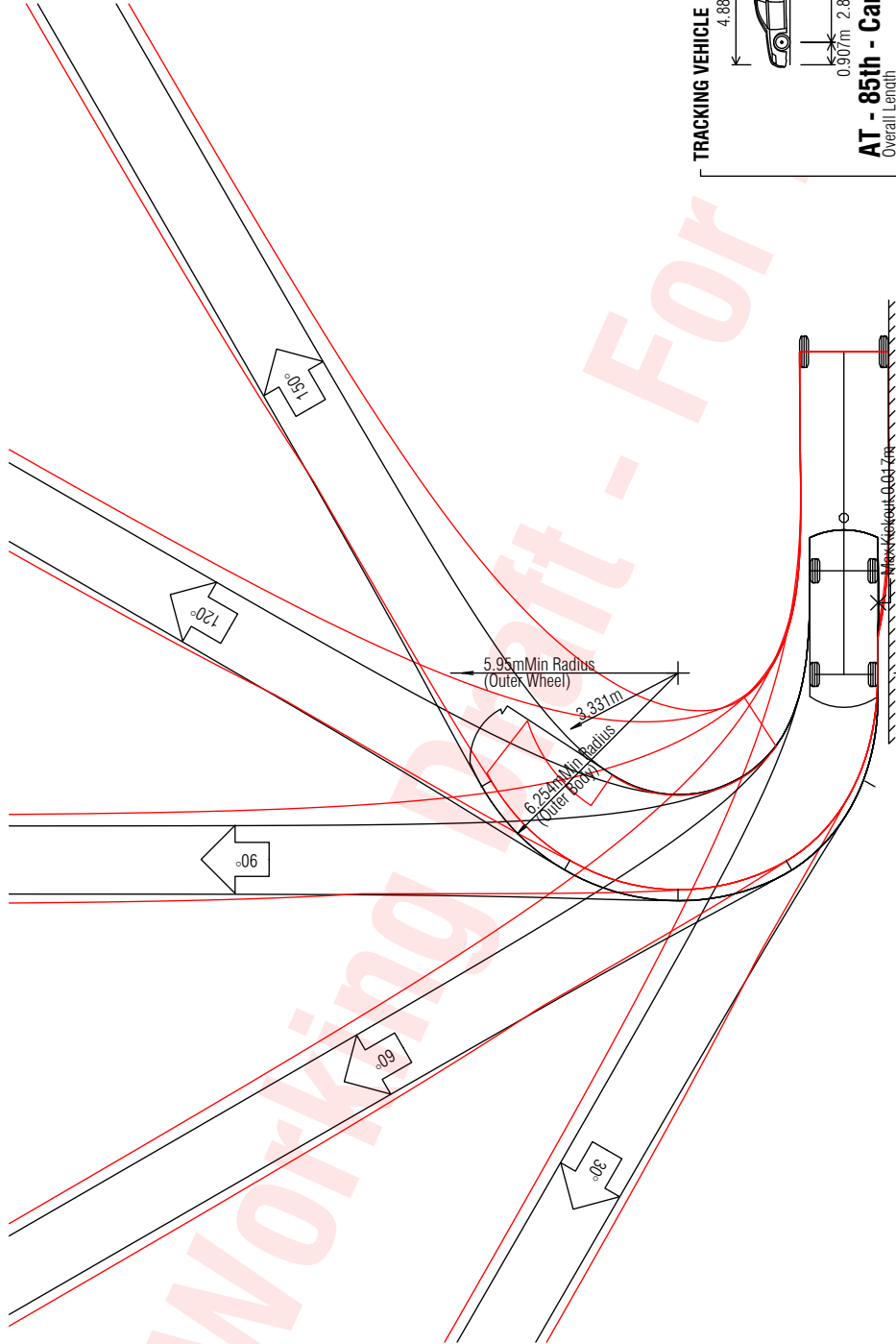

TRACKING VEHICLE

AT - 85th - Car with Boat

Overall Length	10.214m
Overall Width	1.874m
Overall Body Height	1.932m
Min Body Ground Clearance	0.138m
Max Track Width	2.440m
Lock-to-lock time	4.00s
Curb to Curb Turning Radius	5.950m

A4	1:200	
A3	1:100	

Review 1

DATE: August 8, 2021

TDM TECHNICAL STANDARDS

AT - Car - 85th - with Boat

Date: **Document in Review**

SED No.	Version
VT0013	A

Working Draft - For Review

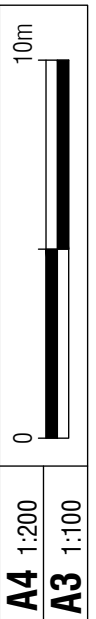
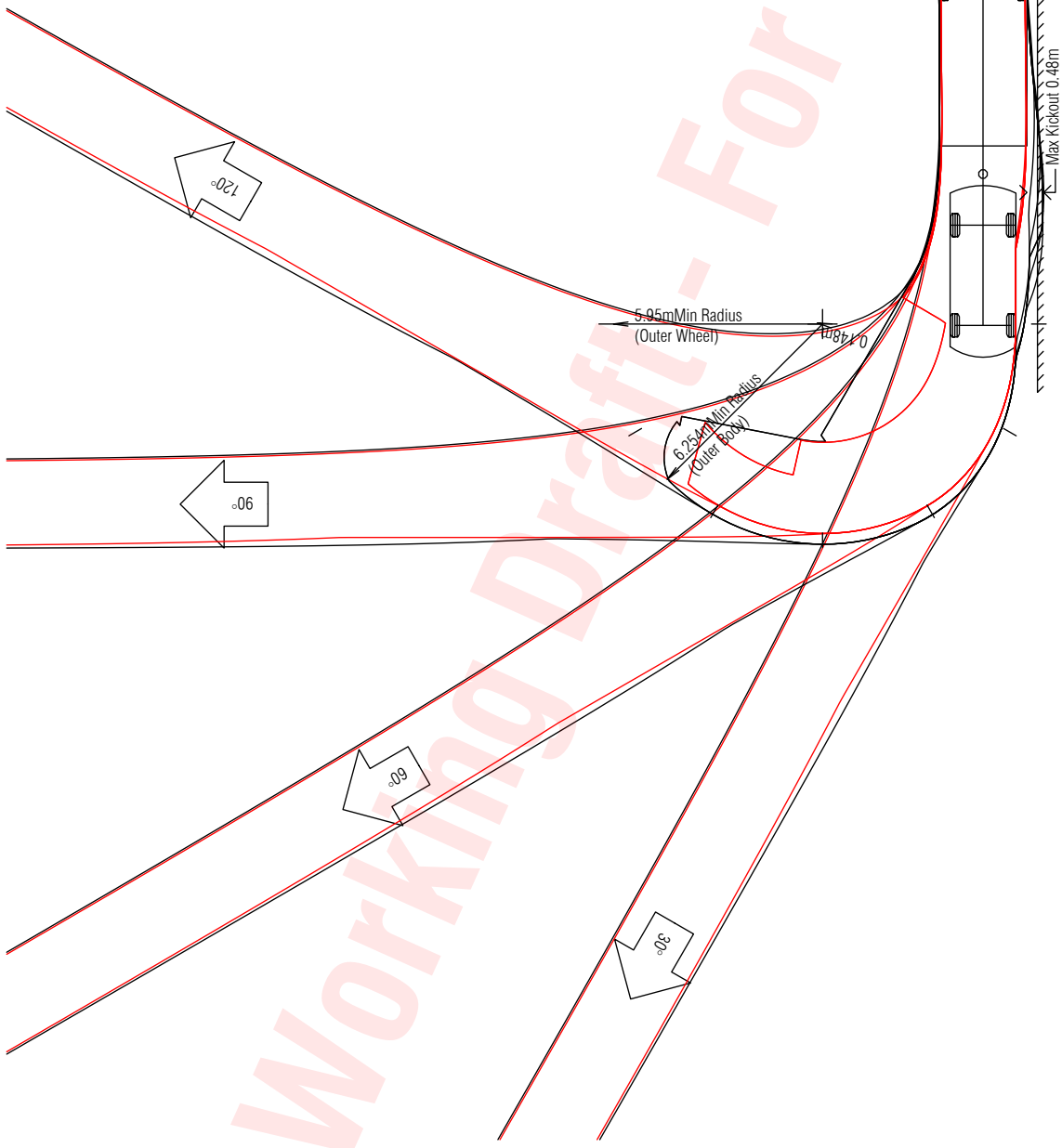
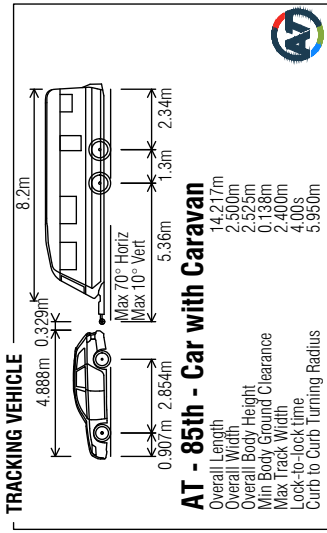

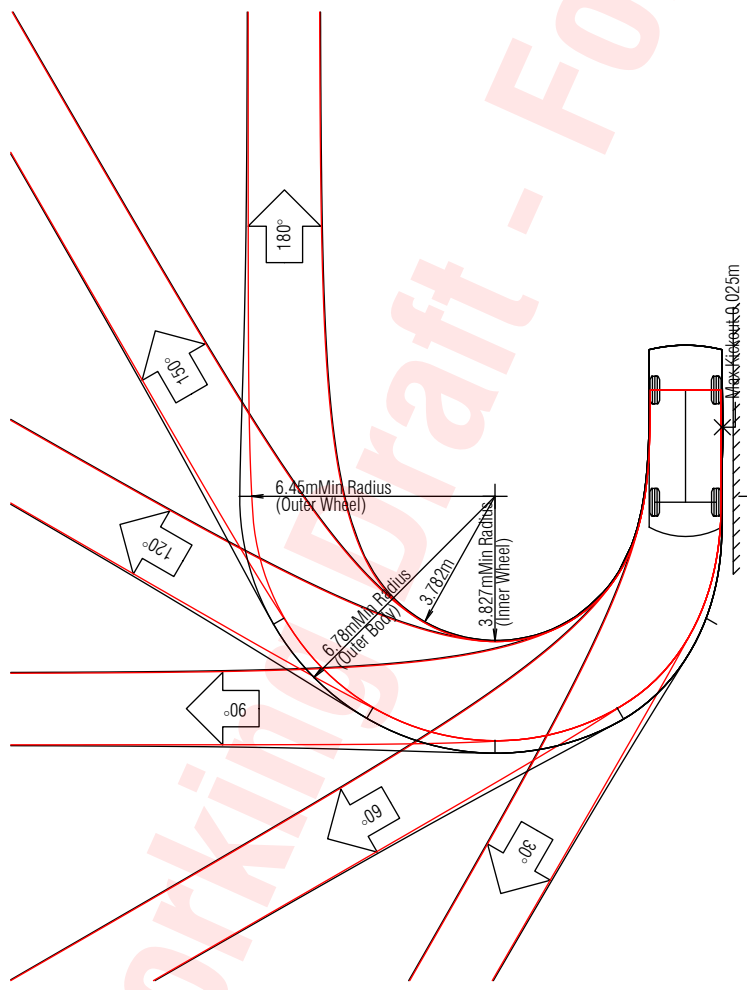

TRACKING VEHICLE

AT - 95th - Car	
Overall Length	5.060m
Overall Width	1.923m
Overall Body Height	1.784m
Min Body Ground Clearance	0.231m
Max Track Width	1.888m
Lock-to-lock time	4.00s
Curb to Curb Turning Radius	6.450m

A4	1:200	
A3	1:100	

TRACKING VEHICLE

AT - Delivery Van

- Overall Length 6.363m
- Overall Width 2.050m
- Overall Body Height 2.432m
- Min Body Ground Clearance 0.206m
- Max Track Width 1.810m
- Lock-to-lock time 4.00s
- Curb to Curb Turning Radius 7.200m

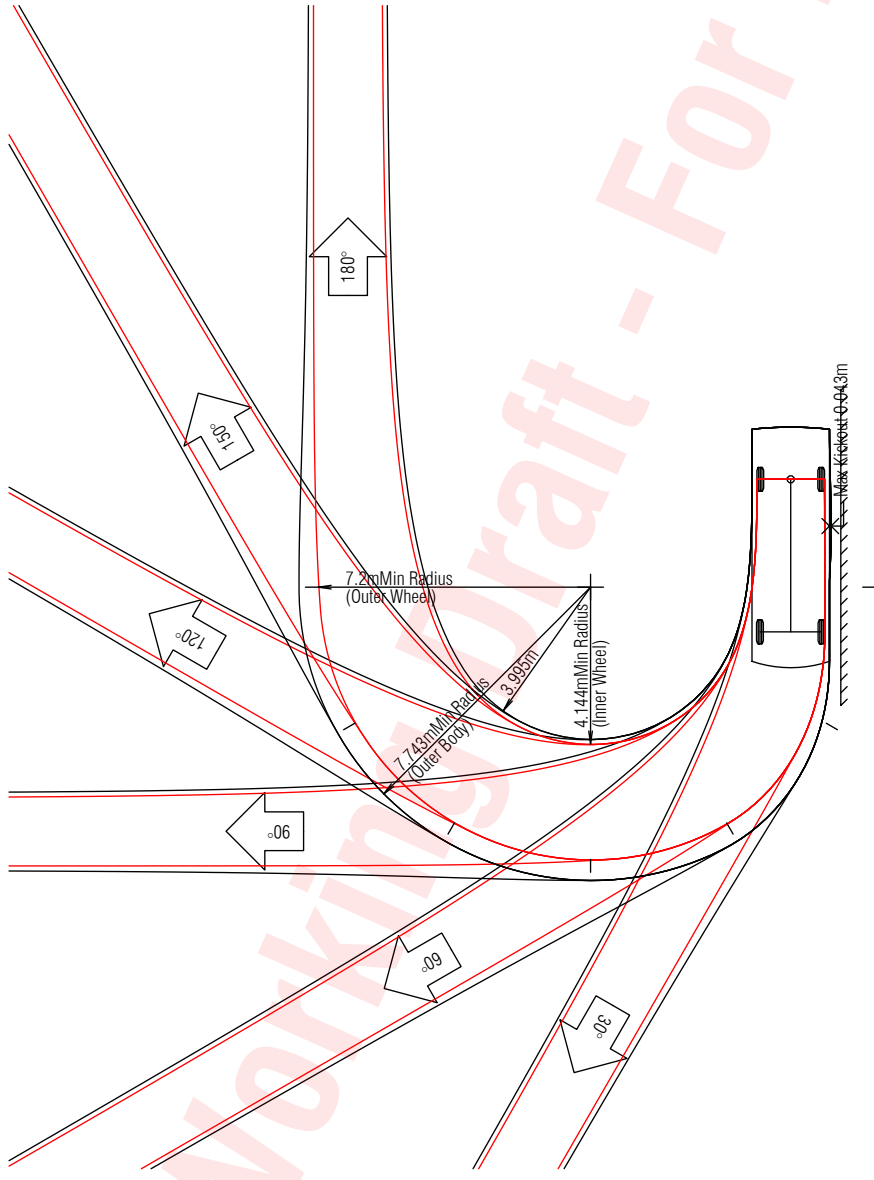

A4	1:200
A3	1:100

Review 1

DATE: August 8, 2021

TDM TECHNICAL STANDARDS

AT - Delivery Van

Date: **Document in Review**

SED No. **VT0016** Version **A**

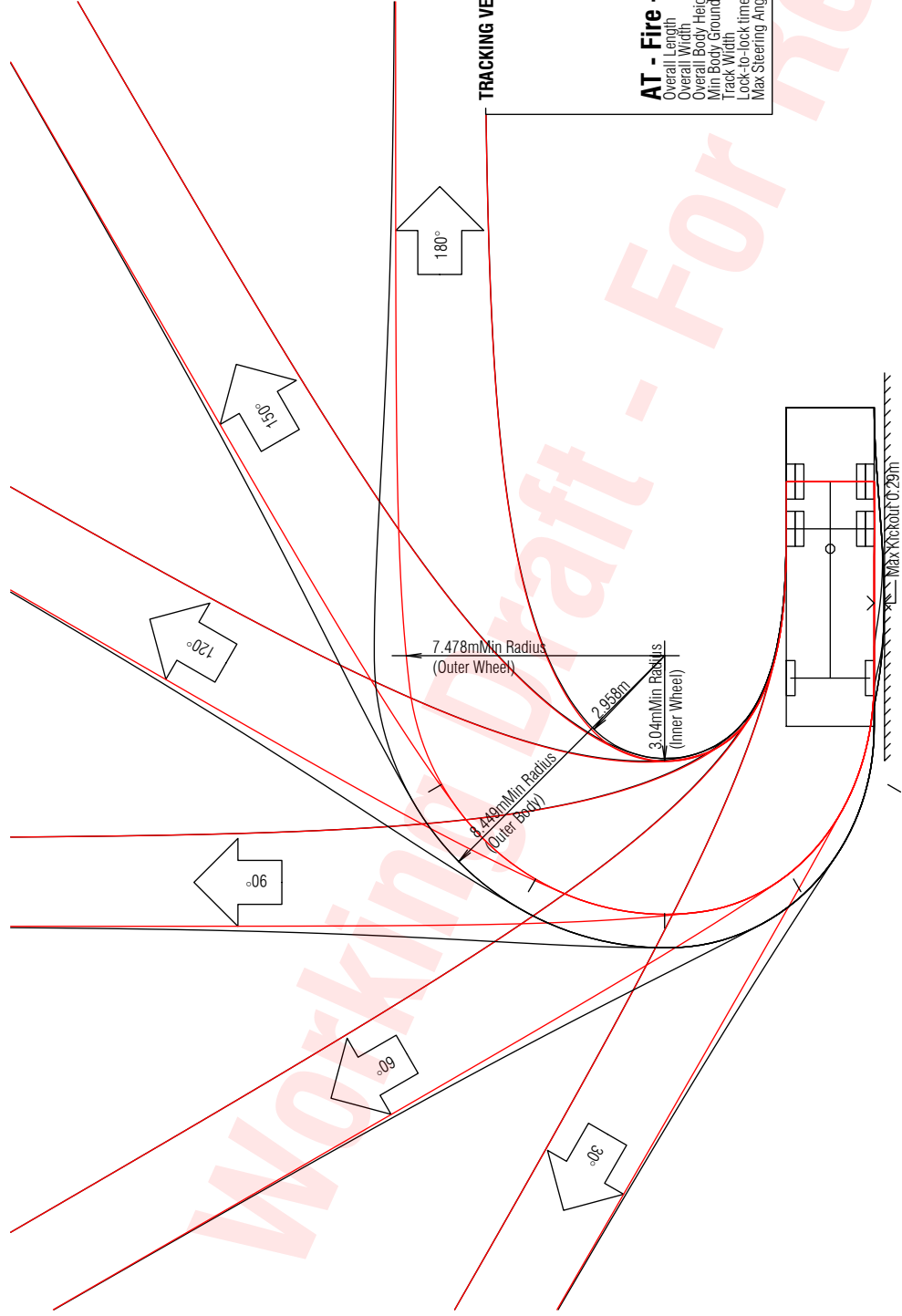

TRACKING VEHICLE

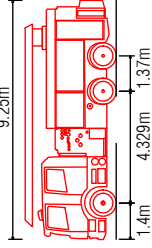

AT - Fire - Aerial unit

- Overall Length 9.250m
- Overall Width 2.650m
- Overall Body Height 3.574m
- Min Body Ground Clearance 0.574m
- Track Width 2.550m
- Lock-to-lock time 6.00s
- Max Steering Angle (Virtual) 49.7°



A4	1:200
A3	1:100

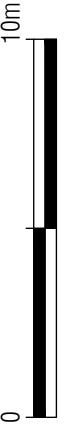

Review 1

DATE: August 8, 2021

TDM TECHNICAL STANDARDS

AT - Fire - Aerial Unit

Date: **Document in Review**

SED No. **VT0030** Version **A**

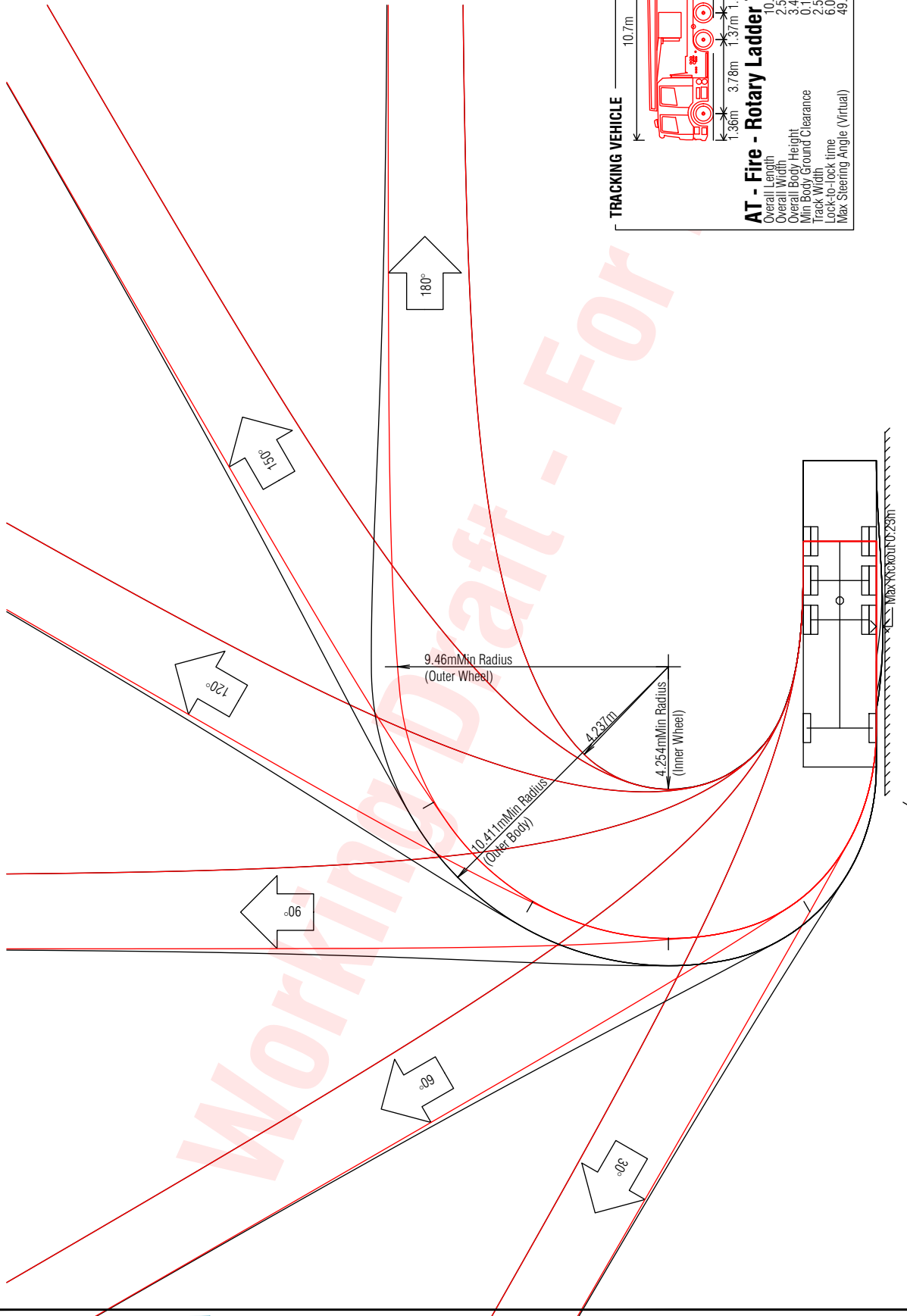

TRACKING VEHICLE

AT - Fire - Rotary Ladder Truck

Overall Length	10.700m
Overall Width	2.550m
Overall Body Height	3.406m
Min Body Ground Clearance	0.173m
Track Width	2.550m
Lock-to-lock time	6.00s
Max Steering Angle (Virtual)	49.70°

A4	1:200	
A3	1:100	

Review 1

DATE: August 8, 2021

TDM TECHNICAL STANDARDS

AT - Fire - Rotary Ladder Truck - 10.7m

Date: **Document in Review**

SED No. **VT0031** Version **A**

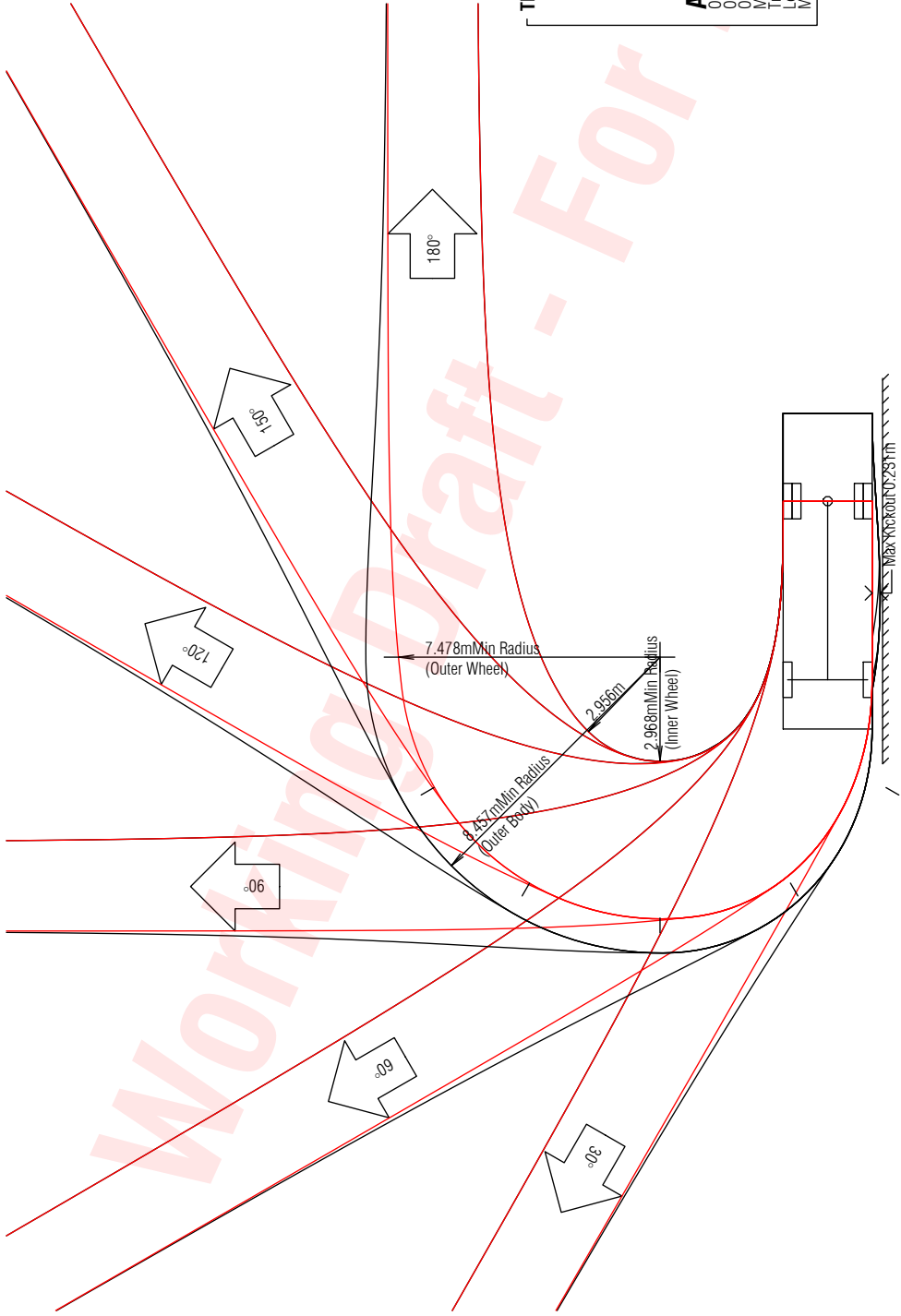

TRACKING VEHICLE

AT - Fire - STD Pumper

- Overall Length: 9.050m
- Overall Width: 2.550m
- Overall Body Height: 3.246m
- Min Body Ground Clearance: 0.274m
- Track Width: 2.550m
- Lock-to-lock time: 6.00s
- Max Steering Angle (Virtual): 49.70°

A4	1:200	0 10m
A3	1:100	

Review 1

DATE: August 8, 2021

TDM TECHNICAL STANDARDS

AT - Fire - STD Pumper

Date: **Document in Review**

SED No. **VT0032** Version **A**

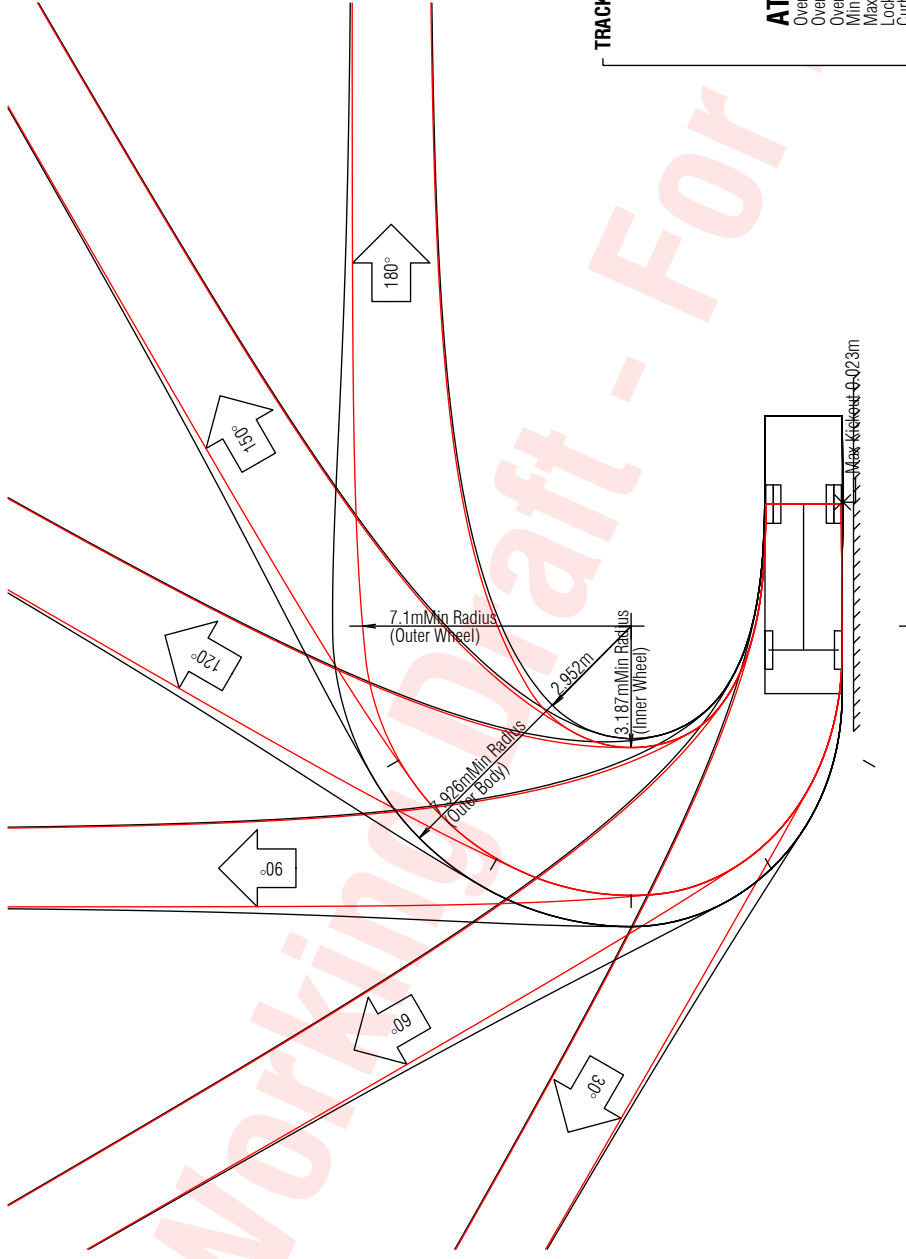

TRACKING VEHICLE

AT - Rubbish - 7.3m - Rear load

- Overall Length: 7.346m
- Overall Width: 2.043m
- Overall Body Height: 3.703m
- Min Body Ground Clearance: 0.498m
- Max Track Width: 2.043m
- Lock-to-lock time: 6.00s
- Curb to Curb Turning Radius: 7.100m

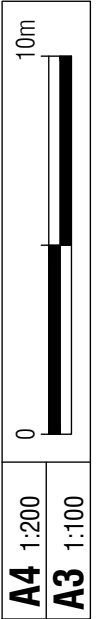

Review 1

DATE: August 8, 2021

TDM TECHNICAL STANDARDS

AT - Rubbish - 7.3m - Rear load

Date: **Document in Review**

SED No. **VT0040** Version **A**

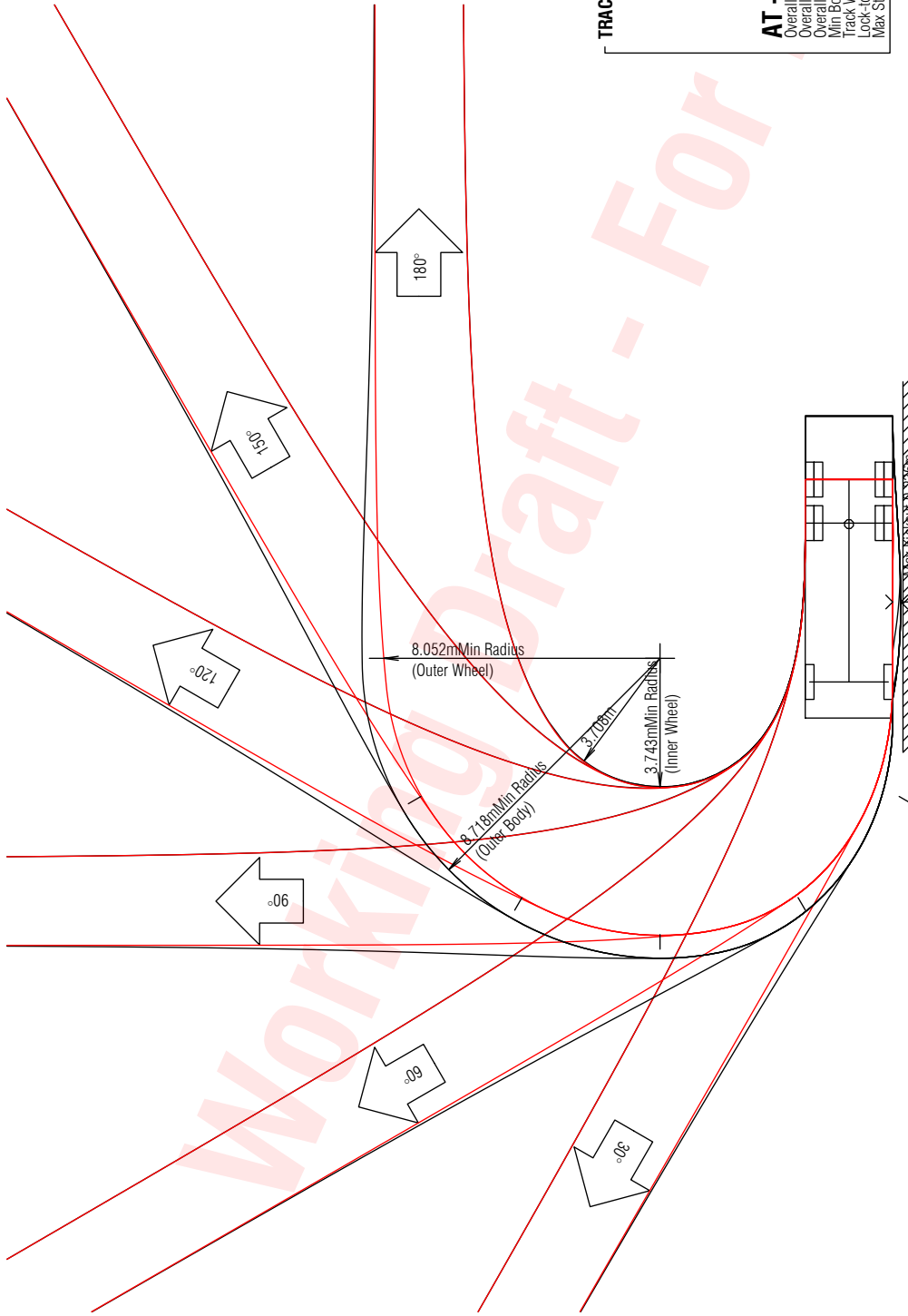

TRACKING VEHICLE

AT - Rubbish - 8.8m - Front load

- Overall Length: 8800mm
- Overall Width: 2550mm
- Overall Body Height: 4088mm
- Min Body Ground Clearance: 0.415m
- Track Width: 2550mm
- Lock-to-lock time: 6.00s
- Max Steering Angle (Virtual): 45.00°

A4	1:200	
A3	1:100	

Review 1

DATE: August 8, 2021

TDM TECHNICAL STANDARDS

AT - Rubbish - 8.8m - Front Load - Fixed Rear

Date: **Document in Review**

SED No. **VT0041** Version **A**

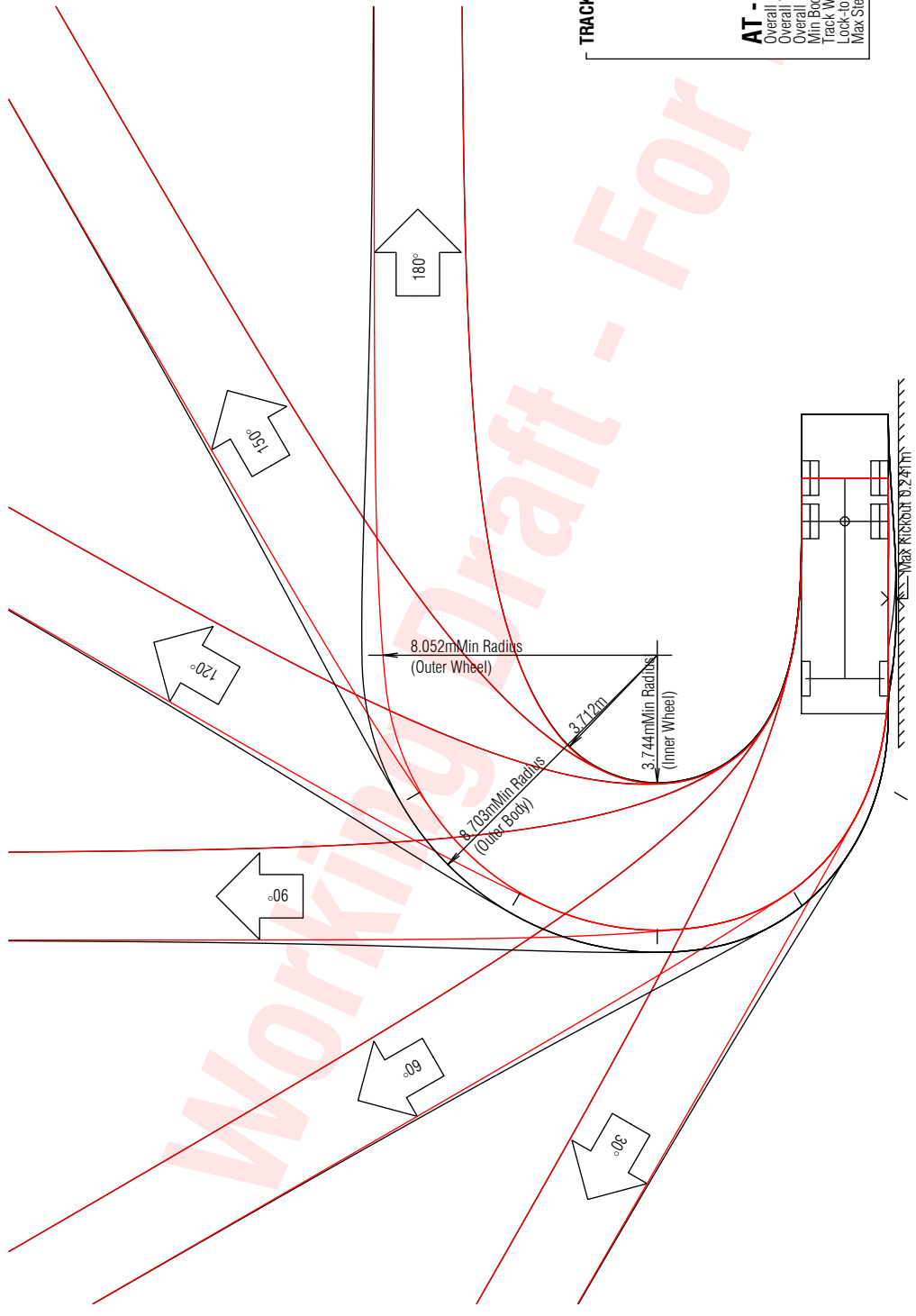

TRACKING VEHICLE

AT - Rubbish - 8.8m - Side load

- Overall Length: 8.800m
- Overall Width: 2.550m
- Overall Body Height: 3.821m
- Min Body Ground Clearance: 0.443m
- Track Width: 2.550m
- Lock-to-lock time: 6.00s
- Max Steering Angle (Virtual): 45.00°

A4	1:200
A3	1:100

Review 1

DATE: August 8, 2021

TDM TECHNICAL STANDARDS

AT - Rubbish - 8.8m - Side Load - Rear Steer

Date: **Document in Review**

SED No. **VT0042** Version **A**

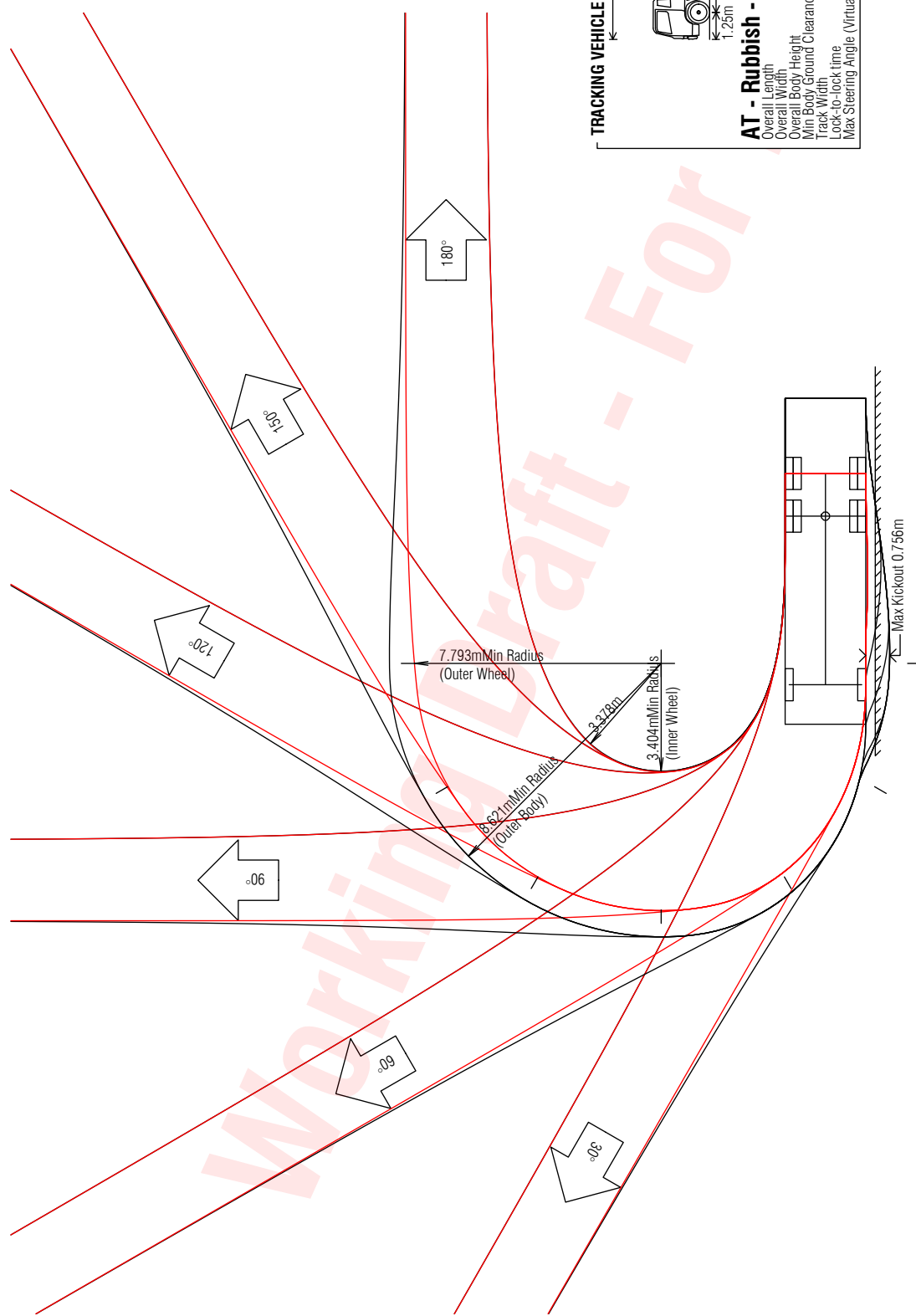

TRACKING VEHICLE

AT - Rubbish - 10.3m - Side load

- Overall Length: 10.300m
- Overall Width: 2.550m
- Overall Body Height: 4.163m
- Min Body Ground Clearance: 0.443m
- Track Width: 2.550m
- Lock-to-lock time: 6.00s
- Max Steering Angle (Virtual): 47.00°

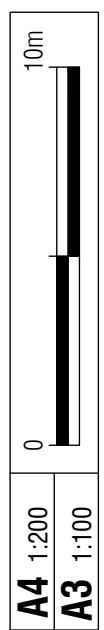

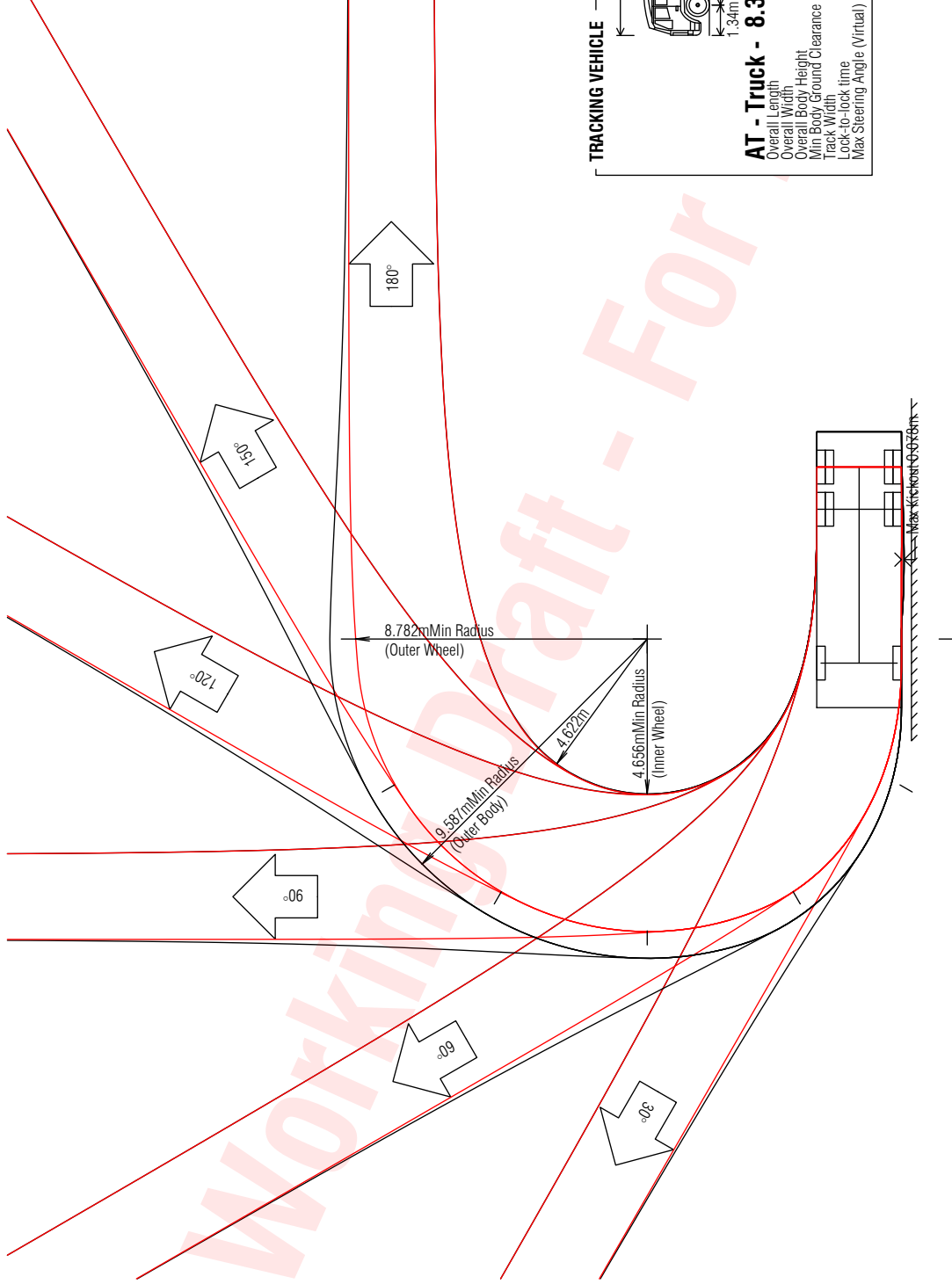

TRACKING VEHICLE

AT - Truck - 8.3m Truck

Overall Length	8.300m
Overall Width	2.550m
Overall Body Height	3.471m
Min Body Ground Clearance	0.373m
Track Width	2.550m
Lock-to-lock time	6.00s
Max Steering Angle (Virtual)	40.20°

A4	1:200	
A3	1:100	

Review 1

DATE: August 8, 2021

TDM TECHNICAL STANDARDS

AT - Truck - 8.3m Truck

Date: **Document in Review**

SED No. **VT0050** Version **A**

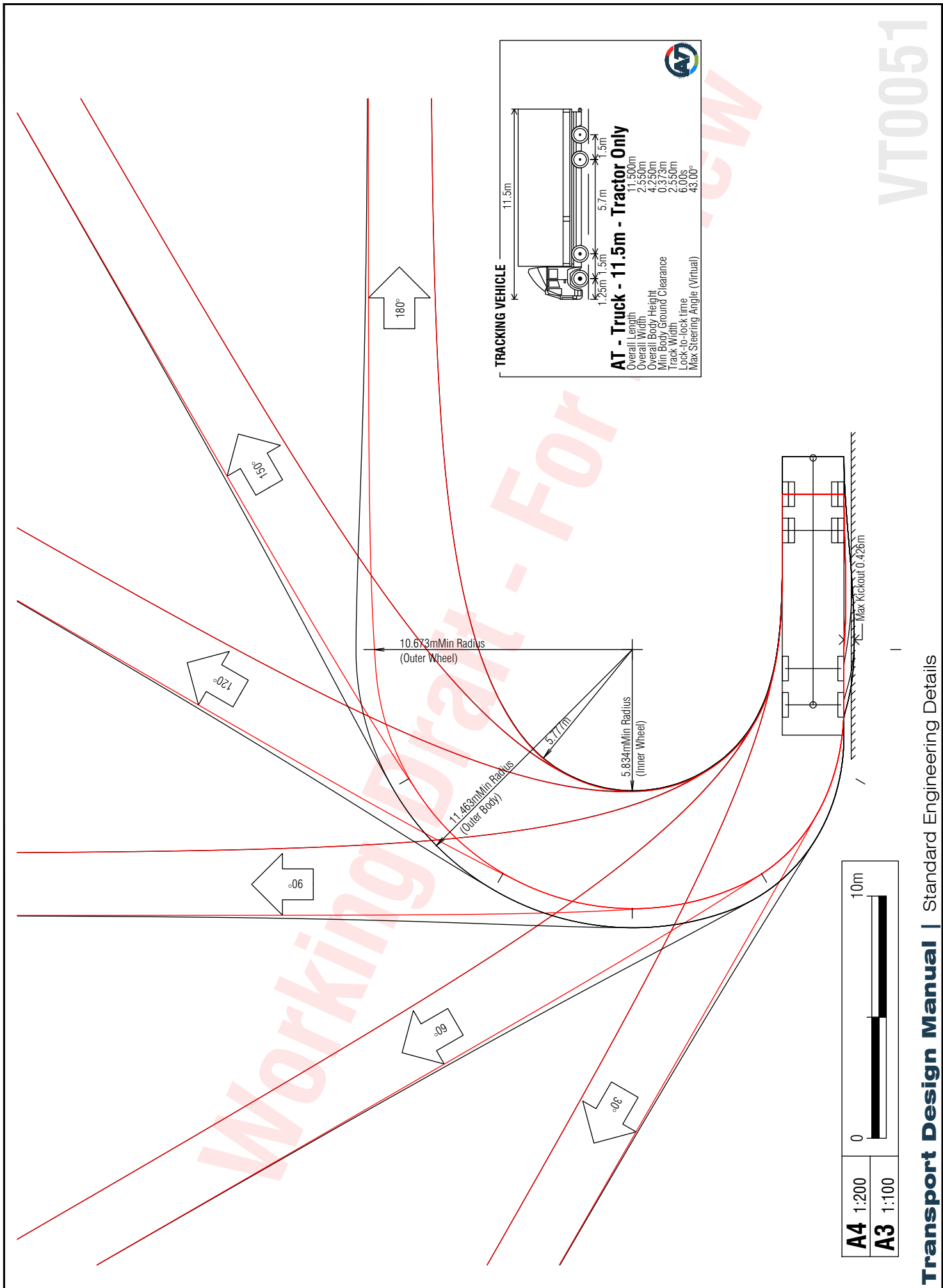

Review **1**

DATE: August 8, 2021

TDM TECHNICAL STANDARDS

AT - Truck - 11.5m Truck

Date: **Document in Review**

SED No. **VT0051** Version **A**

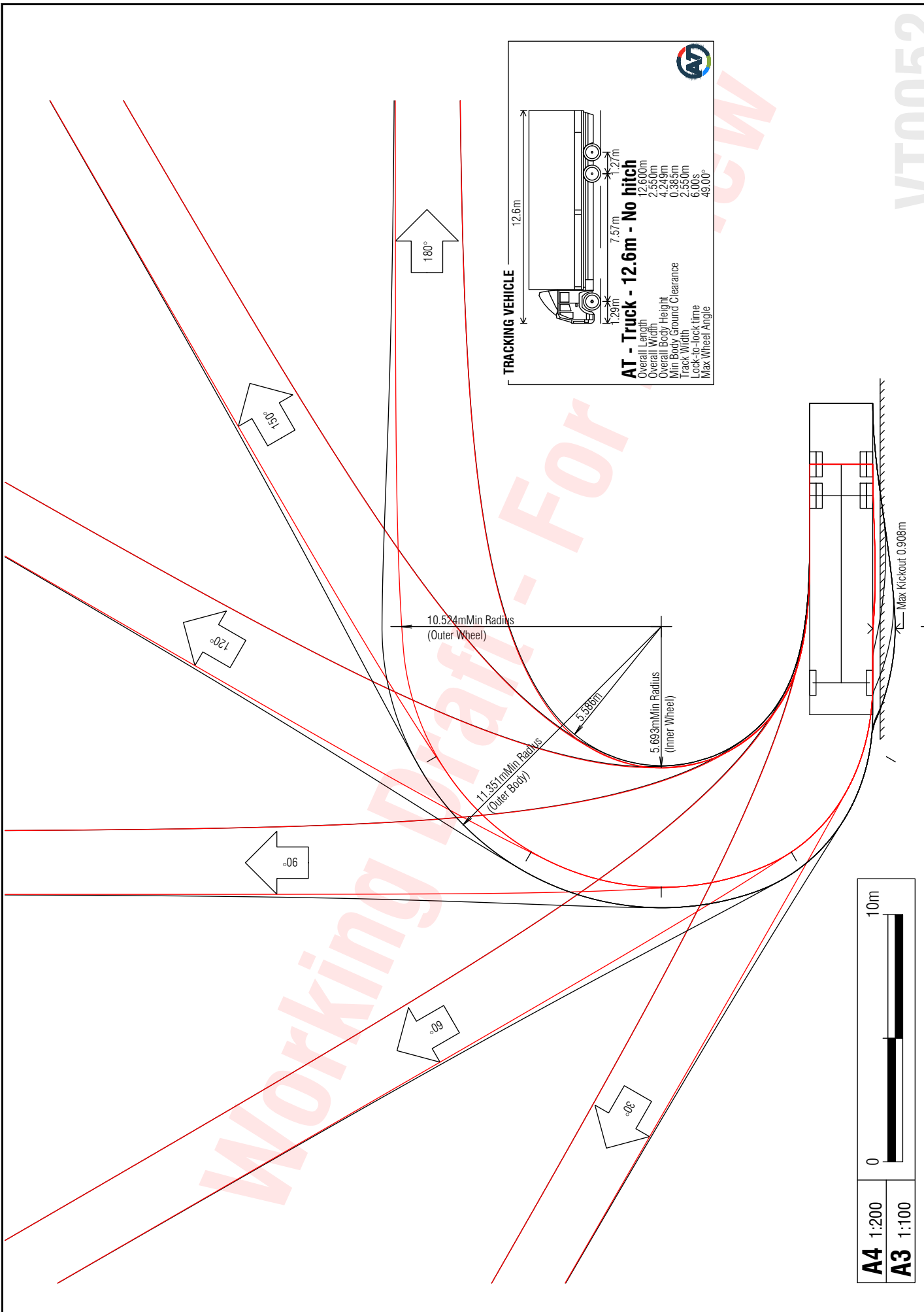

TRACKING VEHICLE

AT - Truck - 12.6m - No hitch

- Overall Length: 12.600m
- Overall Width: 2.550m
- Overall Body Height: 4.249m
- Min Body Ground Clearance: 0.385m
- Track Width: 2.550m
- Lock-to-lock time: 6.00s
- Max Wheel Angle: 49.00°

A4	1:200
A3	1:100

Review 1

DATE: August 8, 2021

TDM TECHNICAL STANDARDS

AT - Truck - 12.6m Truck

Date: **Document in Review**

SED No. **VT0052** Version **A**

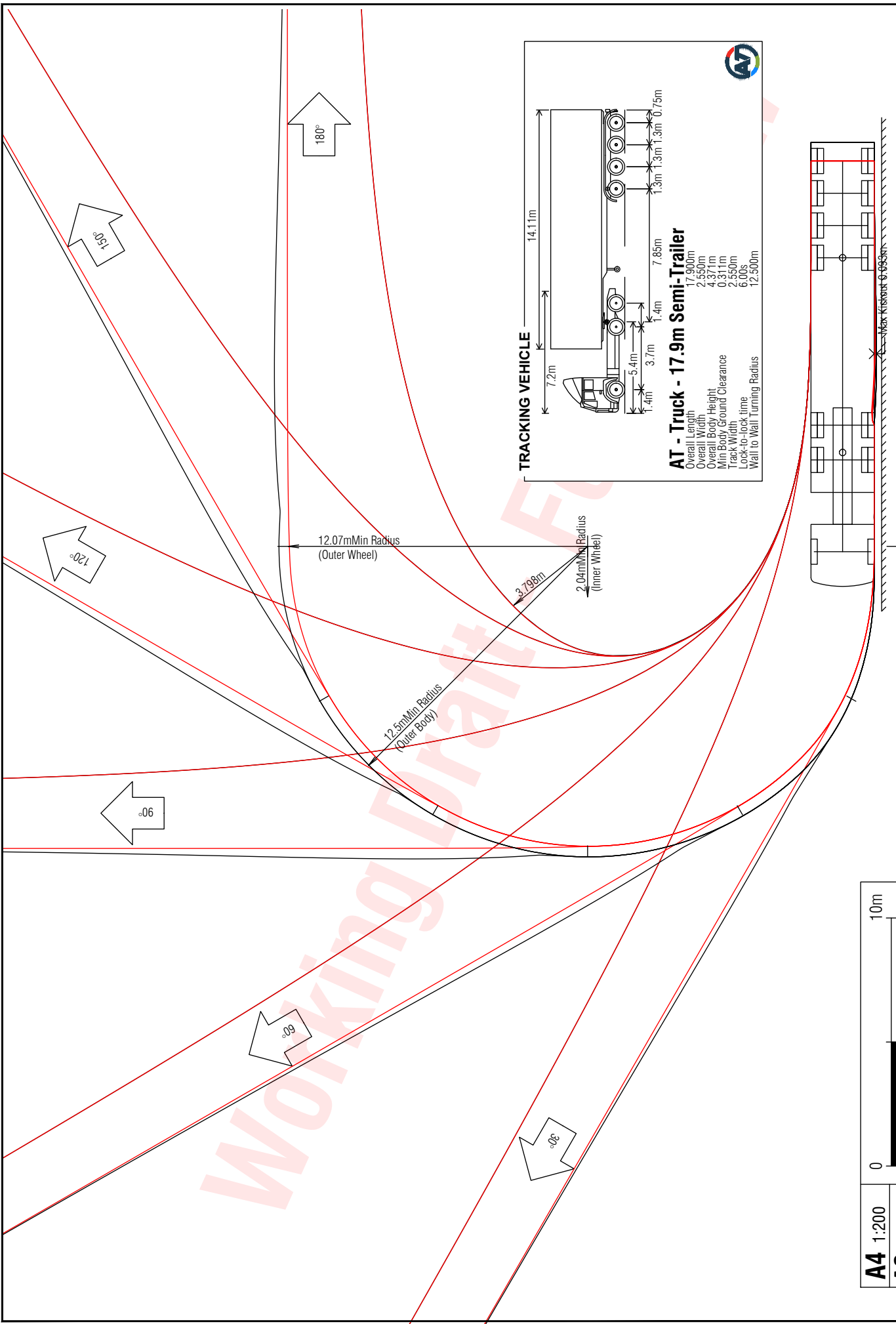

TRACKING VEHICLE

AT - Truck - 17.9m Semi-Trailer

Overall Length	17.900m
Overall Width	2.550m
Overall Body Height	4.371m
Min Body Ground Clearance	0.311m
Track Width	2.550m
Lock-to-lock time	6.00s
Wall to Wall Turning Radius	12.500m

Max Kerbhit 0.993m

A4	1:200
A3	1:100

Review 1

DATE: August 8, 2021

TDM TECHNICAL STANDARDS

AT - Truck - 17.9m Semi (RTS18)

Date: **Document in Review**

SED No. **VT0053** Version **A**

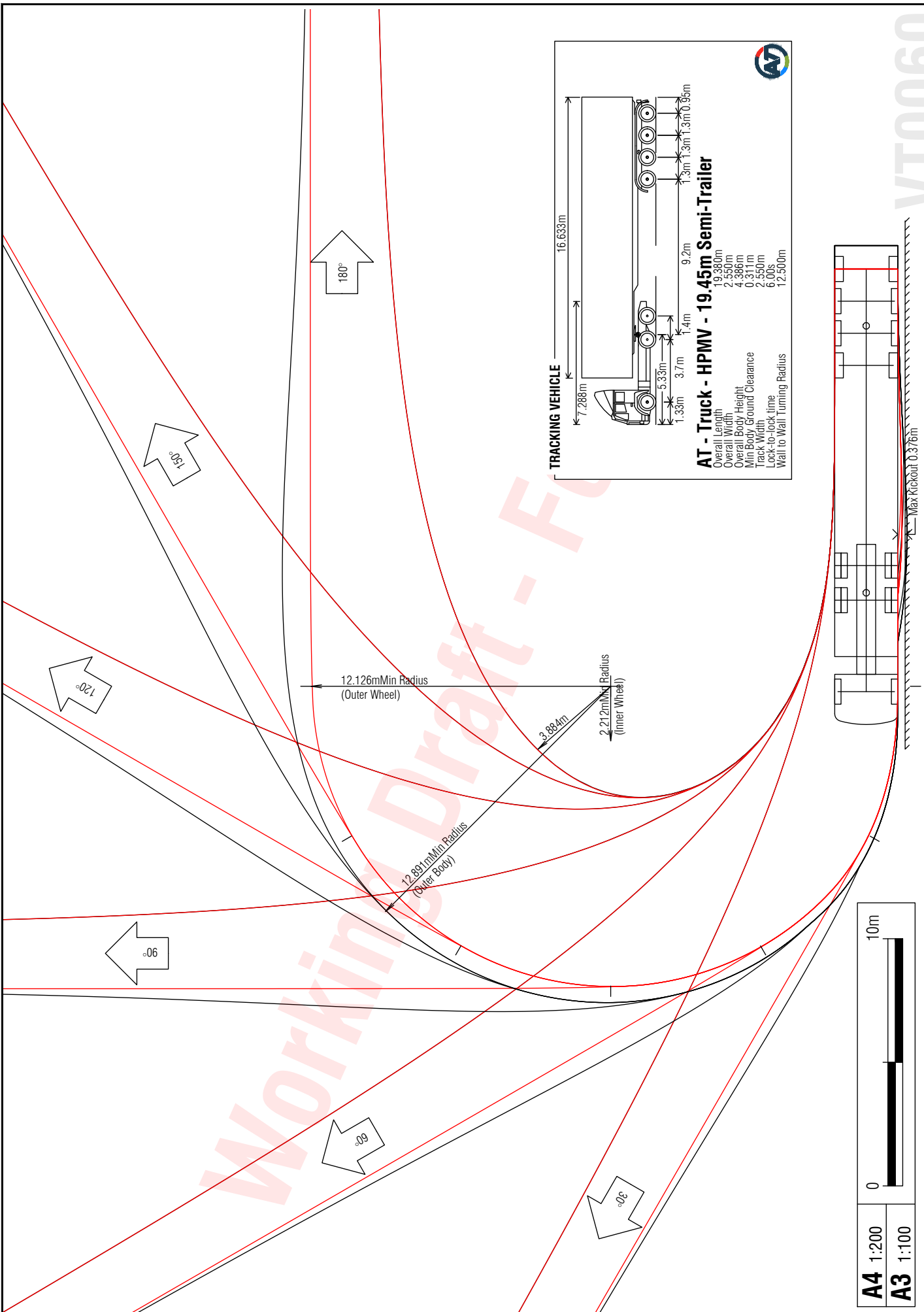

TRACKING VEHICLE

AT - Truck - HPMV - 19.45m Semi-Trailer

Overall Length	19.380m
Overall Width	2.550m
Min Body Height	4.386m
Min Body Ground Clearance	0.311m
Track Width	2.550m
Lock-to-lock time	6.00s
Wall to Wall Turning Radius	12.500m

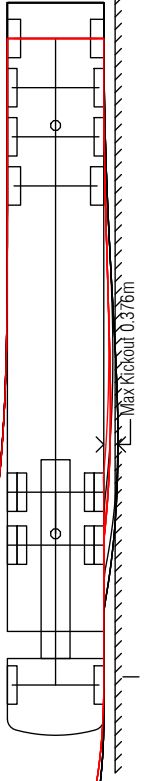

A4	1:200
A3	1:100

Review 1

DATE: August 8, 2021

TDM TECHNICAL STANDARDS

AT - Truck - HPMV - 19.45m Semi

Date: **Document in Review**

SED No. **VT0060** Version **A**

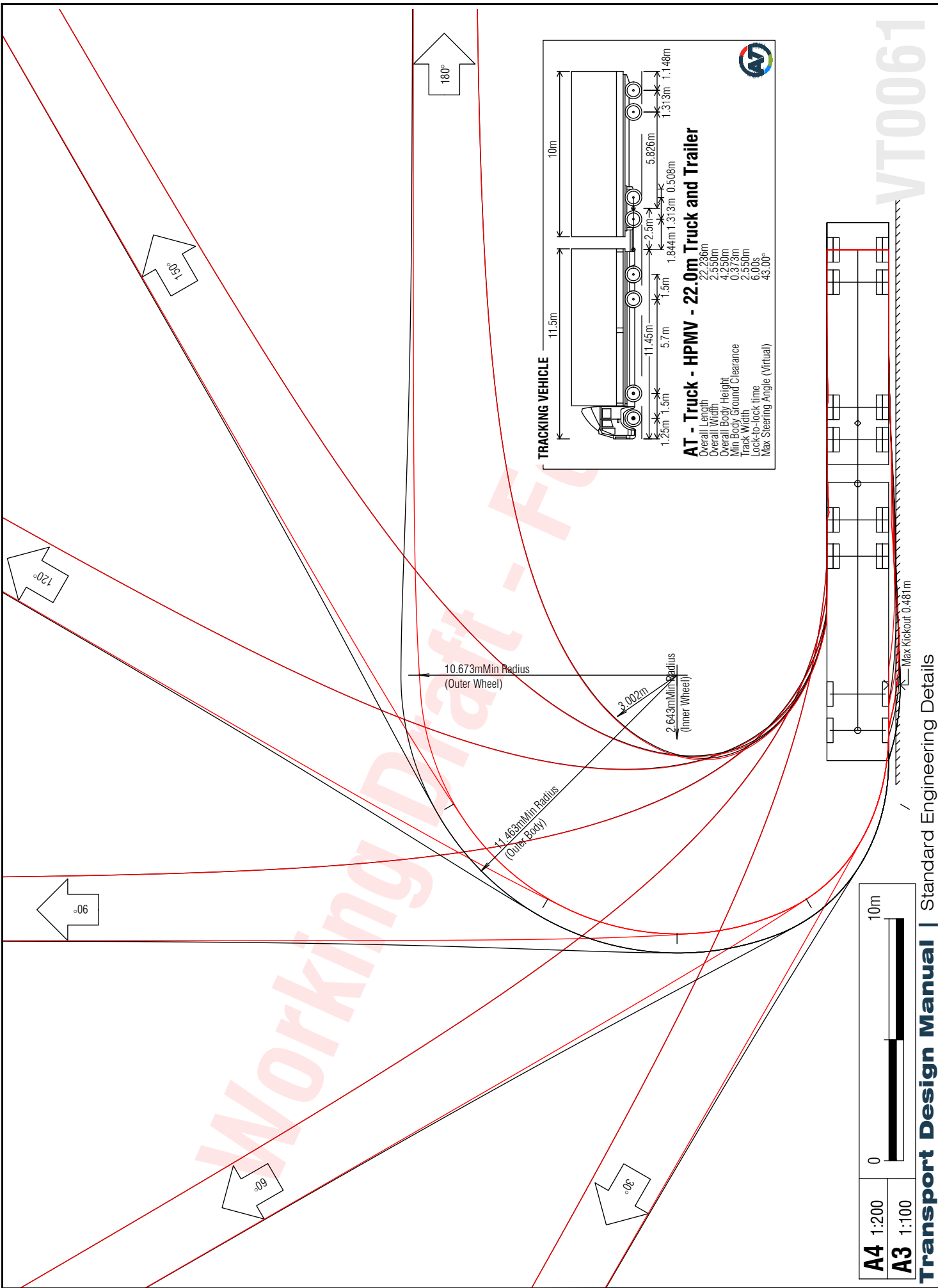

TRACKING VEHICLE

AT - Truck - HPMV - 22.0m Truck and Trailer

Overall Length	22.236m
Overall Width	2.550m
Overall Body Height	4.250m
Min Body Ground Clearance	0.373m
Track Width	2.550m
Lock-to-lock time	6.00S
Max Steering Angle (Virtual)	43.00°

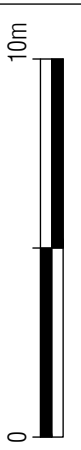
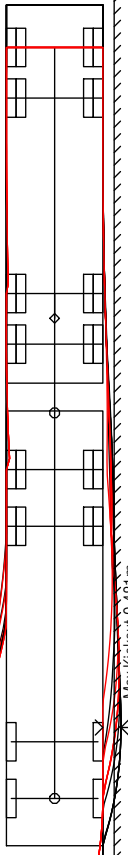

A4 1:200
A3 1:100

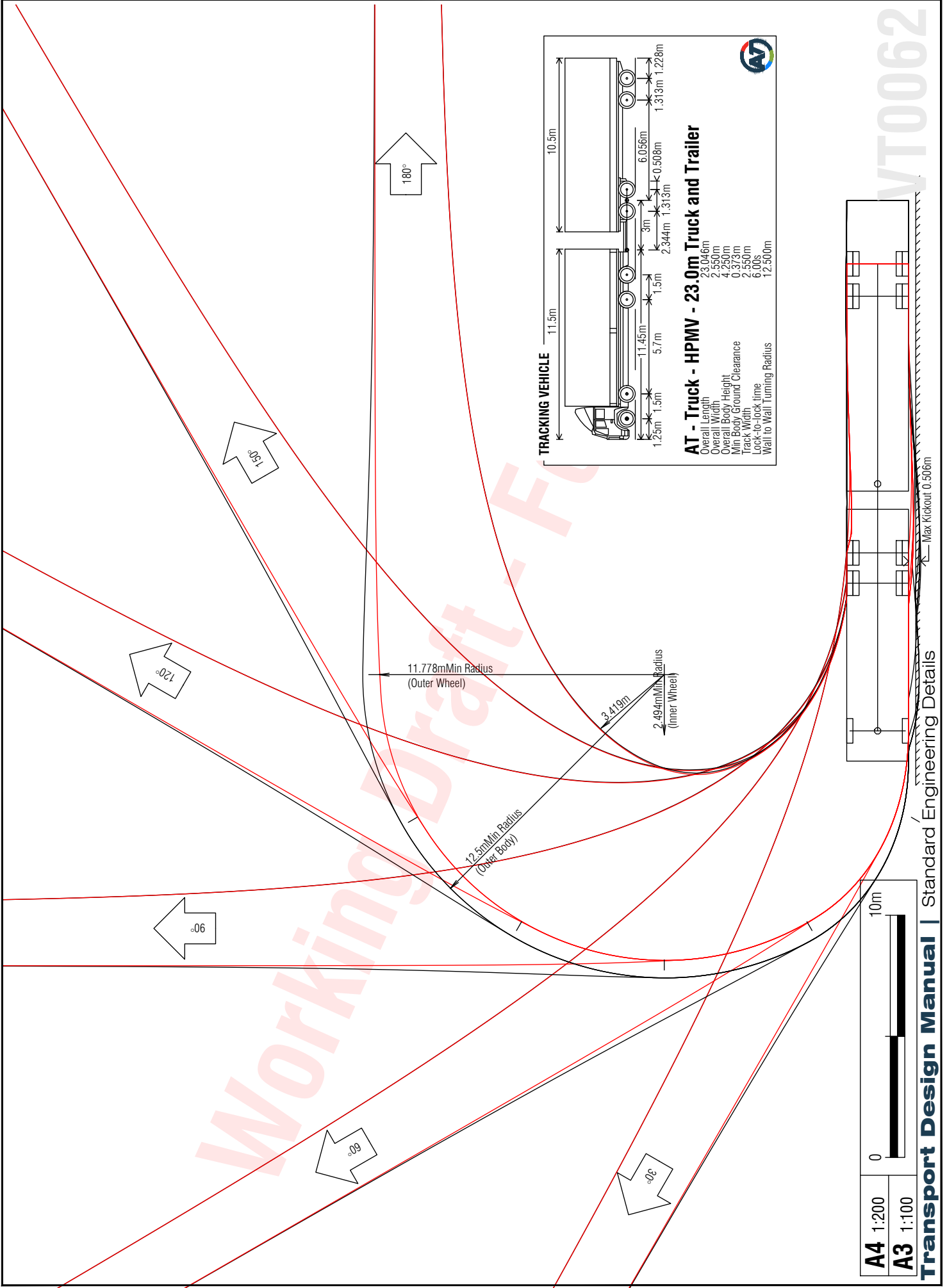

TRACKING VEHICLE

AT - Truck - HPMV - 23.0m Truck and Trailer

Overall Length	23.046m
Overall Width	2.550m
Overall Body Height	4.250m
Min Body Ground Clearance	0.373m
Track Width	2.550m
Lock-to-Lock time	6.00s
Wall to Wall Turning Radius	12.500m

A4 1:200

A3 1:100

10m

Review 1

DATE: August 8, 2021

TDM TECHNICAL STANDARDS

AT - Truck - HPMV - 23.0m T&T

Date: **Document in Review**

SED No. **VT0062** Version **A**

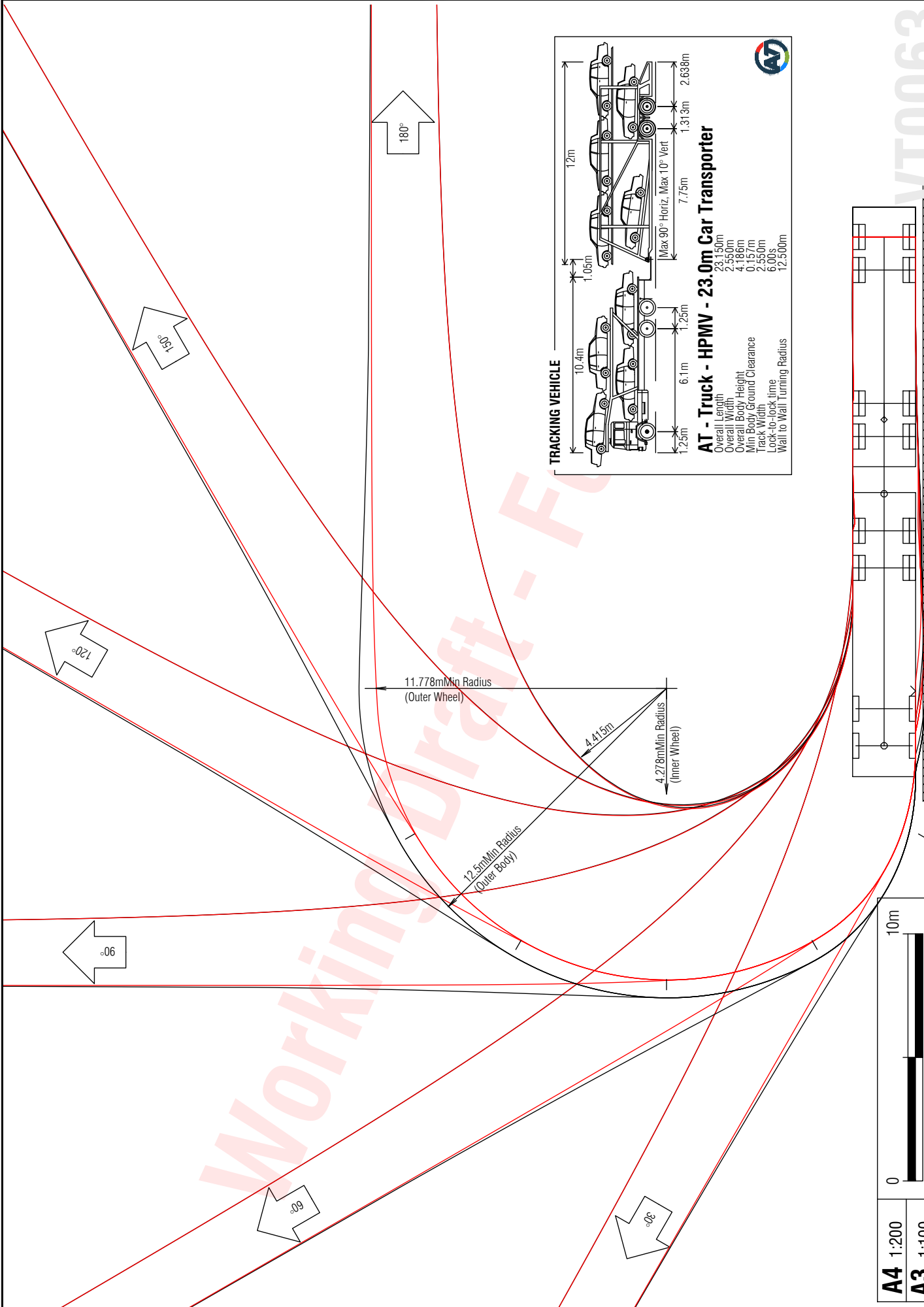

TRACKING VEHICLE

AT - Truck - HPMV - 23.0m Car Transporter

Overall Length	23.150m
Overall Width	2.550m
Overall Body Height	4.186m
Min Body Ground Clearance	0.157m
Track Width	2.550m
Lock-to-lock time	6.00s
Wall to Wall Turning Radius	12.500m

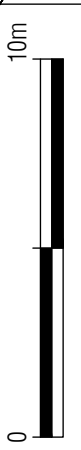
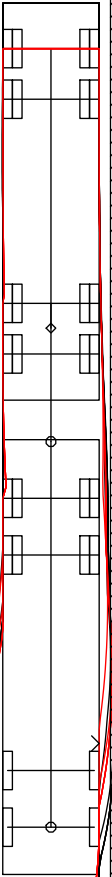

A4 1:200
A3 1:100

Review 1

DATE: August 8, 2021

TDM TECHNICAL STANDARDS
 AT - Truck - HPMV - 23.0m Car Transporter

Date: **Document in Review**
 SED No. **VT0063** Version **A**

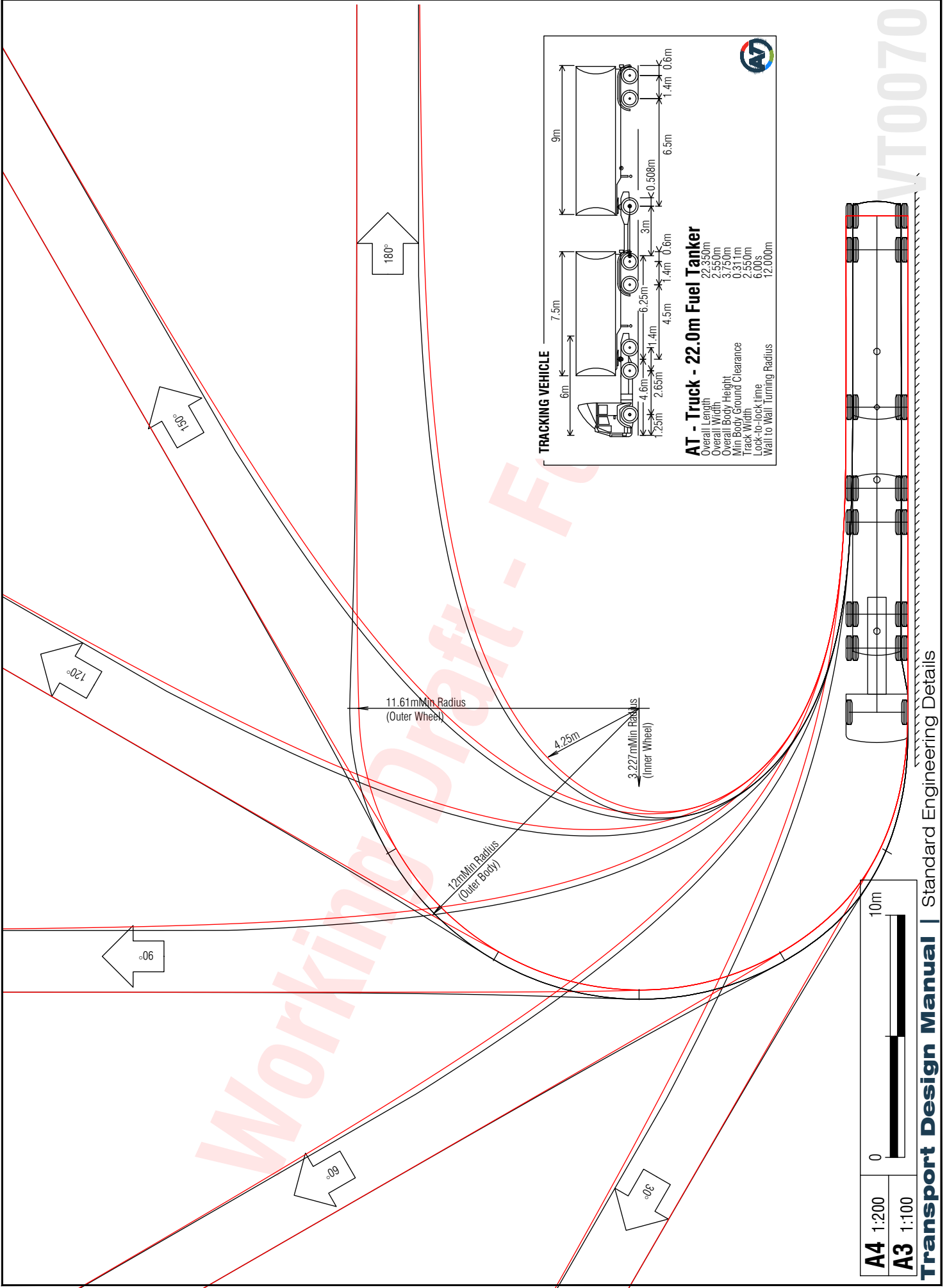

TRACKING VEHICLE

AT - Truck - 22.0m Fuel Tanker

Overall Length	22.350m
Overall Width	3.550m
Min Body Height	0.931m
Track Width	2.550m
Lock to lock time	6.00s
Wait to Wait turning Radius	12.000m

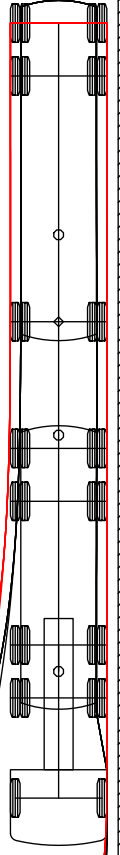

Review 1

DATE: August 8, 2021

TDM TECHNICAL STANDARDS

AT - Special - 22.0m - Fuel Tanker

Date: **Document in Review**

SED No. **VT0070** Version **A**

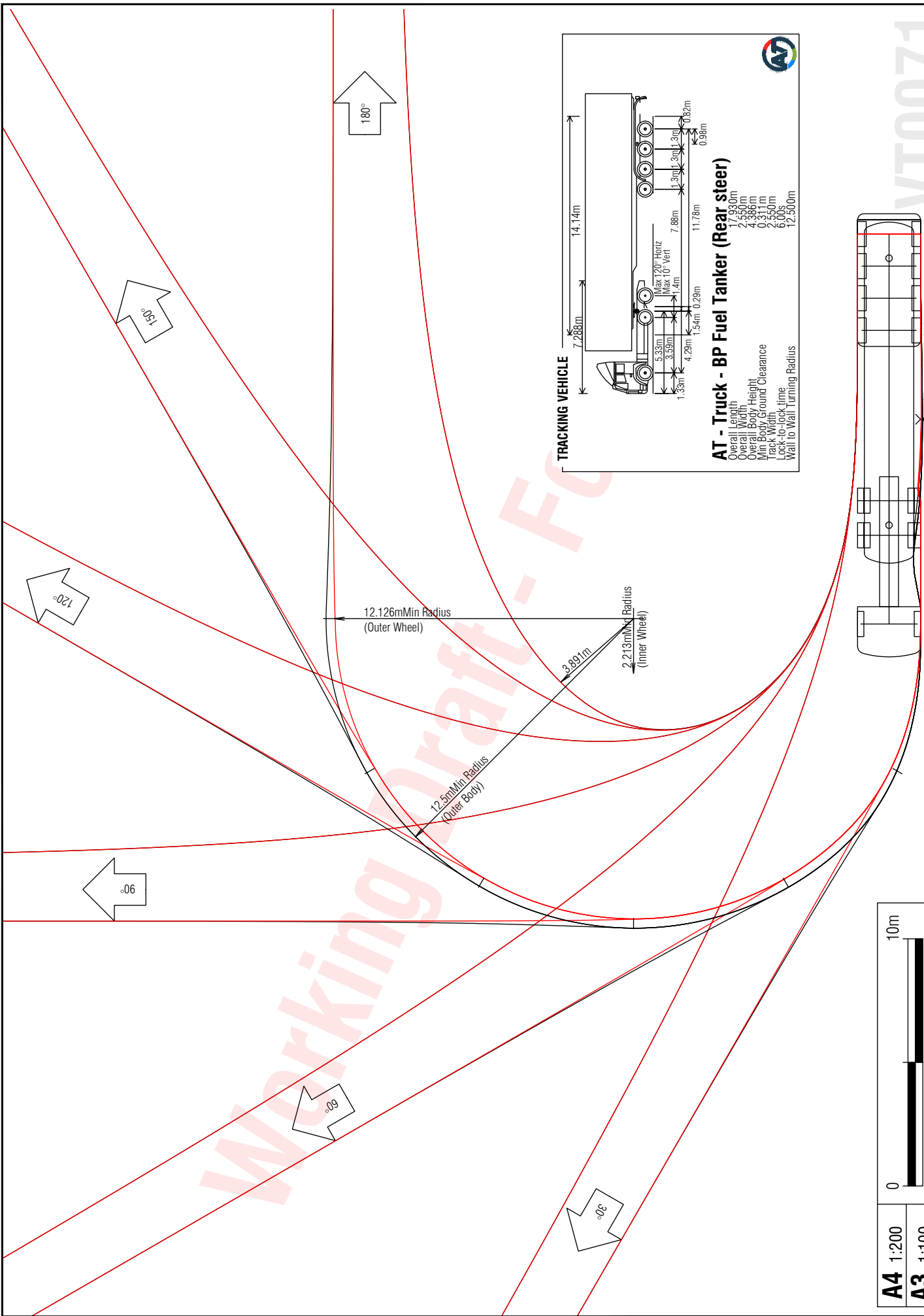

TRACKING VEHICLE

AT - Truck - BP Fuel Tanker (Rear steer)

- Overall Length 14.14m
- Overall Width 2.7550m
- Overall Body Height 4.336m
- Wheelbase 7.288m
- Min Body Ground Clearance 0.331m
- Track Width 2.550m
- Lock-to-lock time 6.00s
- Wall to Wall Turning Radius 12.500m

A4 1:200

A3 1:100

Transport Design Manual | Standard Engineering Details

VT0071

Review 1

DATE: August 8, 2021

TDM TECHNICAL STANDARDS

AT - Truck - BP Fuel Tanker (Rear steer)

Date: **Document in Review**

SED No. **VT0071** Version **A**

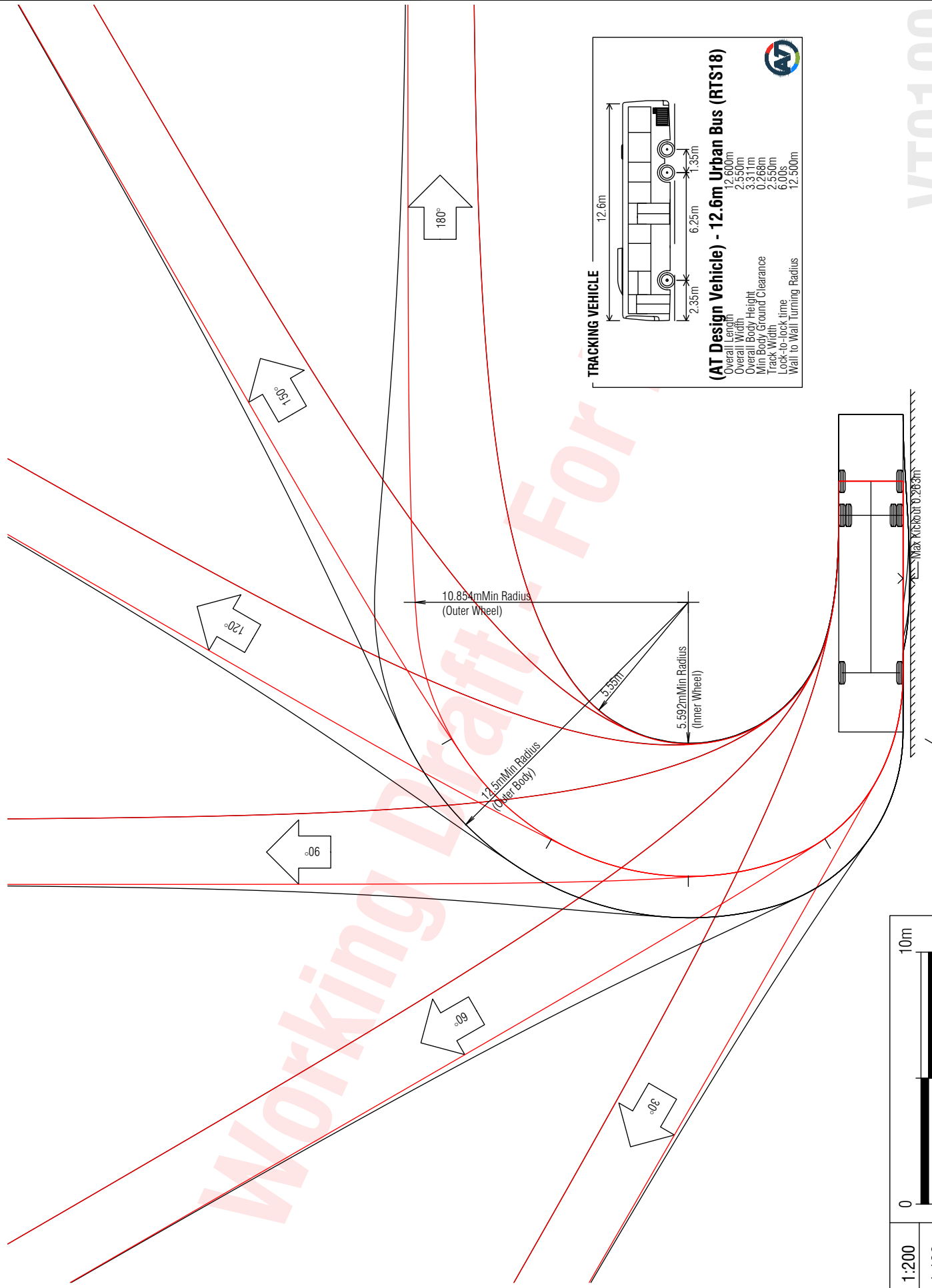

TRACKING VEHICLE

(AT Design Vehicle) - 12.6m Urban Bus (RTS18)

Overall Length	12.600m
Overall Width	2.550m
Overall Body Height	3.311m
Min Body Ground Clearance	0.268m
Track Width	2.550m
Lock-to-lock time	6.00S
Wall to Wall Turning Radius	12.500m

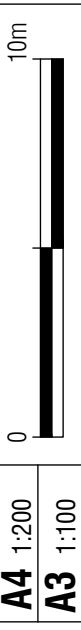

Review 1

DATE: August 8, 2021

TDM TECHNICAL STANDARDS
 (AT Design Vehicle) - 12.6m Urban Bus (RTS18)

Date: **Document in Review**

SED No. **VT0100** Version **A**

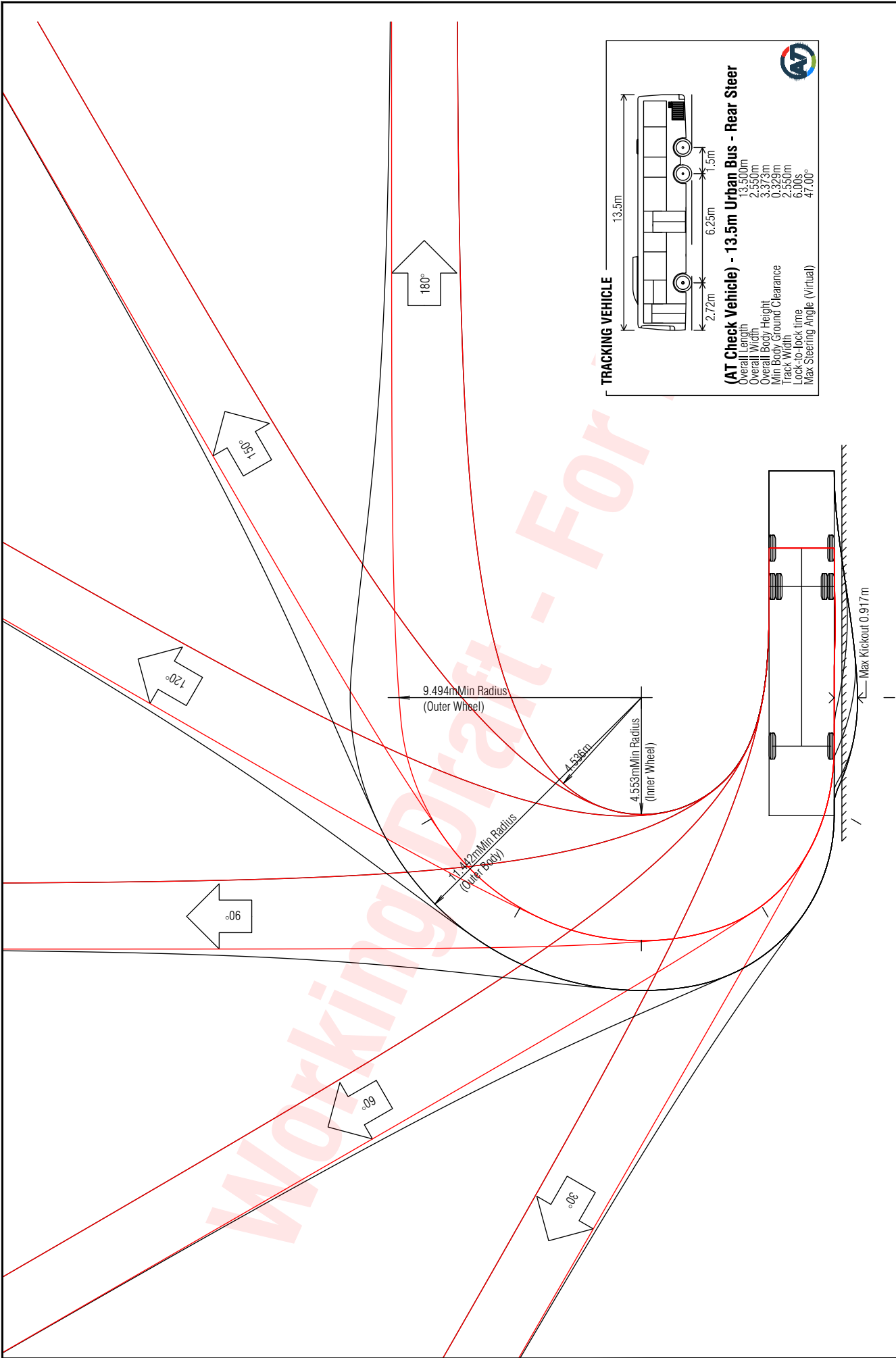

TRACKING VEHICLE

(AT Check Vehicle) - 13.5m Urban Bus - Rear Steer

Overall Length	13.500m
Overall Width	2.550m
Overall Body Height	3.373m
Min Body Ground Clearance	0.329m
Track Width	2.550m
Lock-to-Lock time	6.00S
Max Steering Angle (Virtual)	47.00°

A4	1:200	
A3	1:100	

Review 1

DATE: August 8, 2021

TDM TECHNICAL STANDARDS
 (AT Check Vehicle) - 13.5m Urban Bus - Rear Steer

Date: **Document in Review**

SED No.	Version
VT0101	A

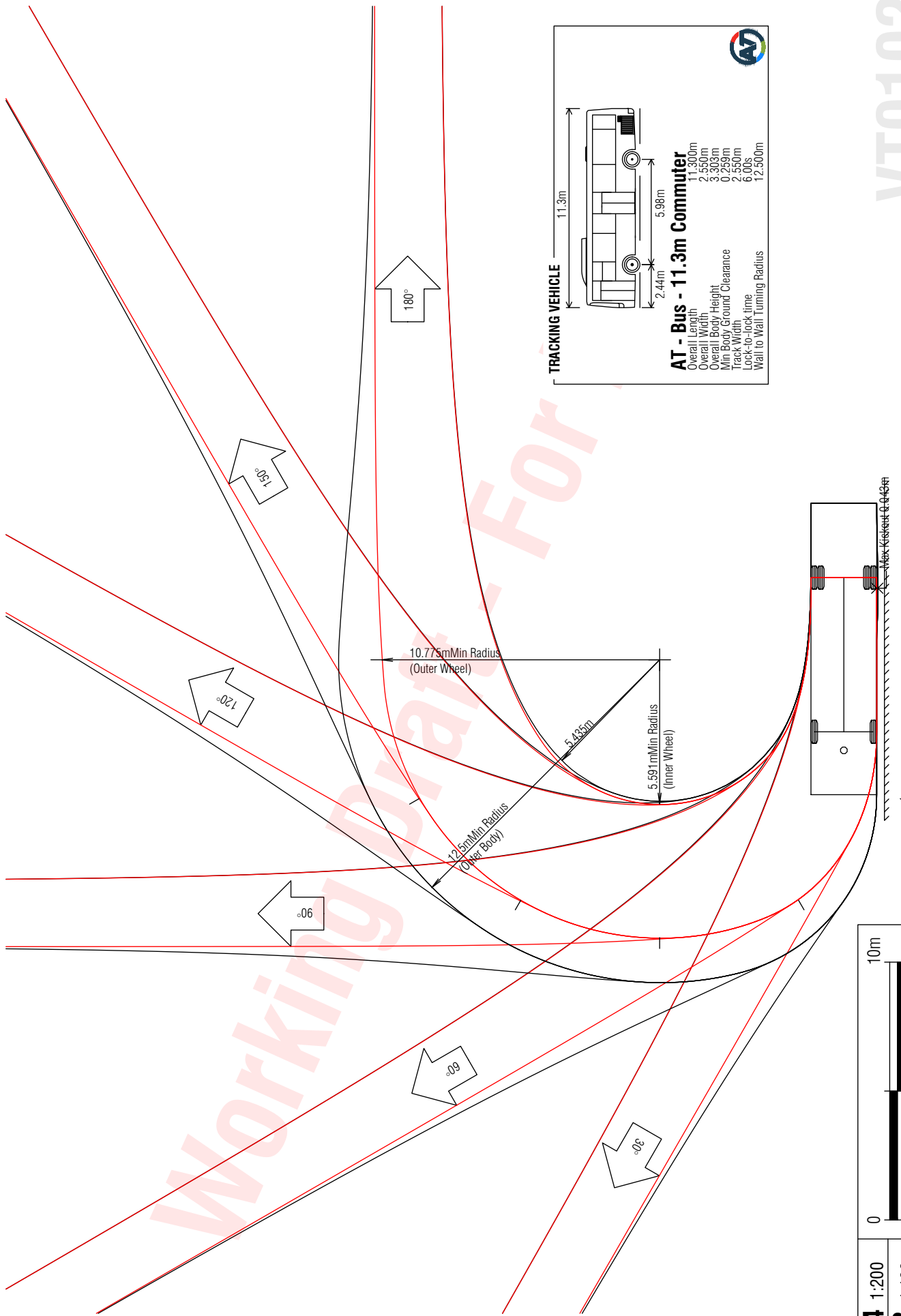

TRACKING VEHICLE

AT - Bus - 11.3m Commuter

Overall Length	11,300mm
Overall Width	2,550mm
Overall Body Height	3,303mm
Min Body Ground Clearance	0,259mm
Track Width	2,550mm
Lock-to-lock time	6,00S
Wall to Wall Turning Radius	12,500mm

A4 1:200

A3 1:100

Review 1

DATE: August 8, 2021

TDM TECHNICAL STANDARDS

AT - Bus - 11.3m Commuter

Date: **Document in Review**

SED No. **VT0102** Version **A**

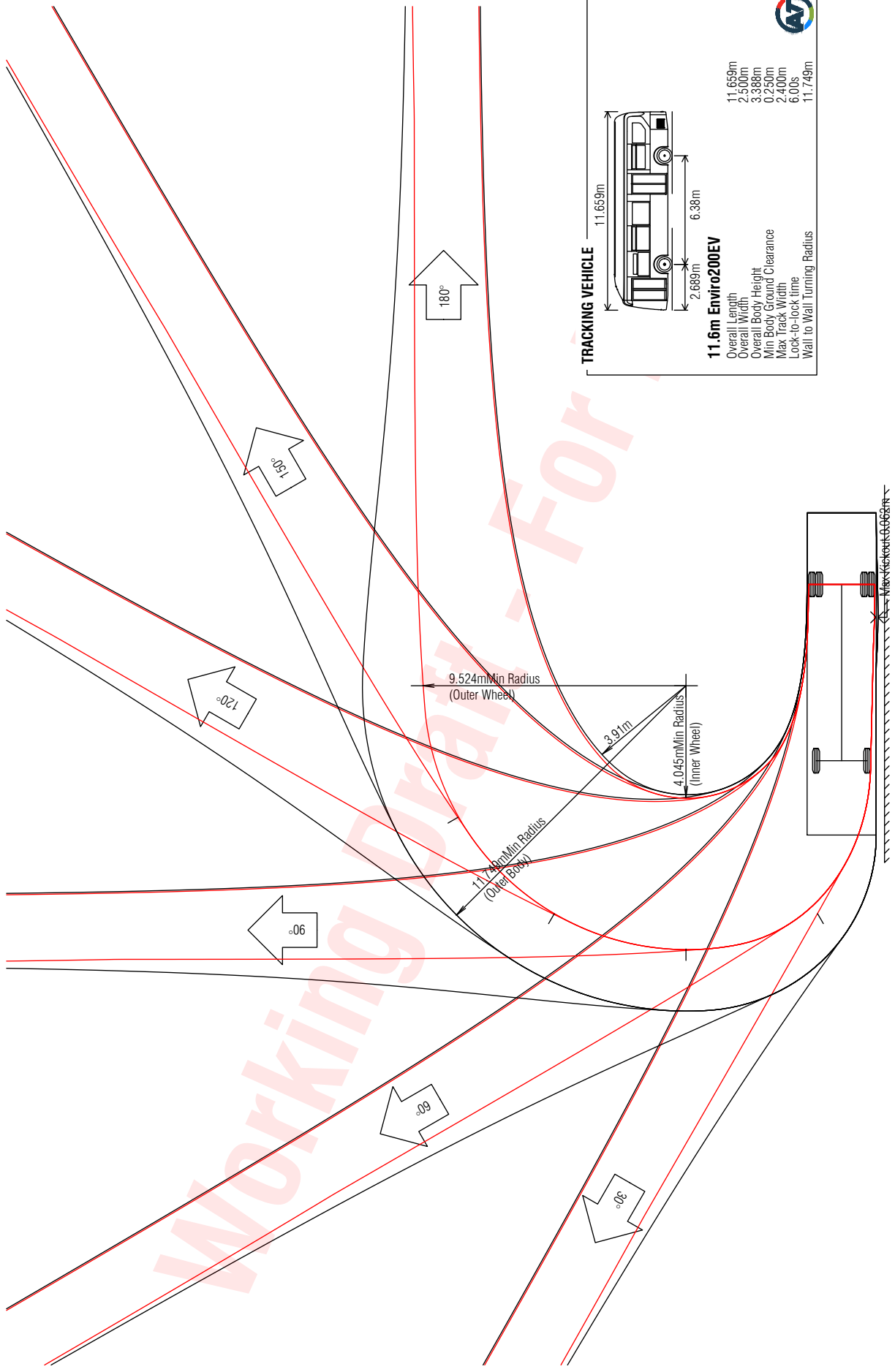

TRACKING VEHICLE

11.6m Enviro200EV

- Overall Length: 11.659m
- Overall Width: 2.689m
- Overall Height: 3.388m
- Min Body Ground Clearance: 0.250m
- Max Track Width: 2.400m
- Lock-to-lock time: 6.00s
- Wall to Wall Turning Radius: 11.749m

A4 1:200

A3 1:100

Review 1

DATE: August 8, 2021

TDM TECHNICAL STANDARDS

AT - 11.6m Enviro200EV

Date: **Document in Review**

SED No. **VT0103** Version **A**

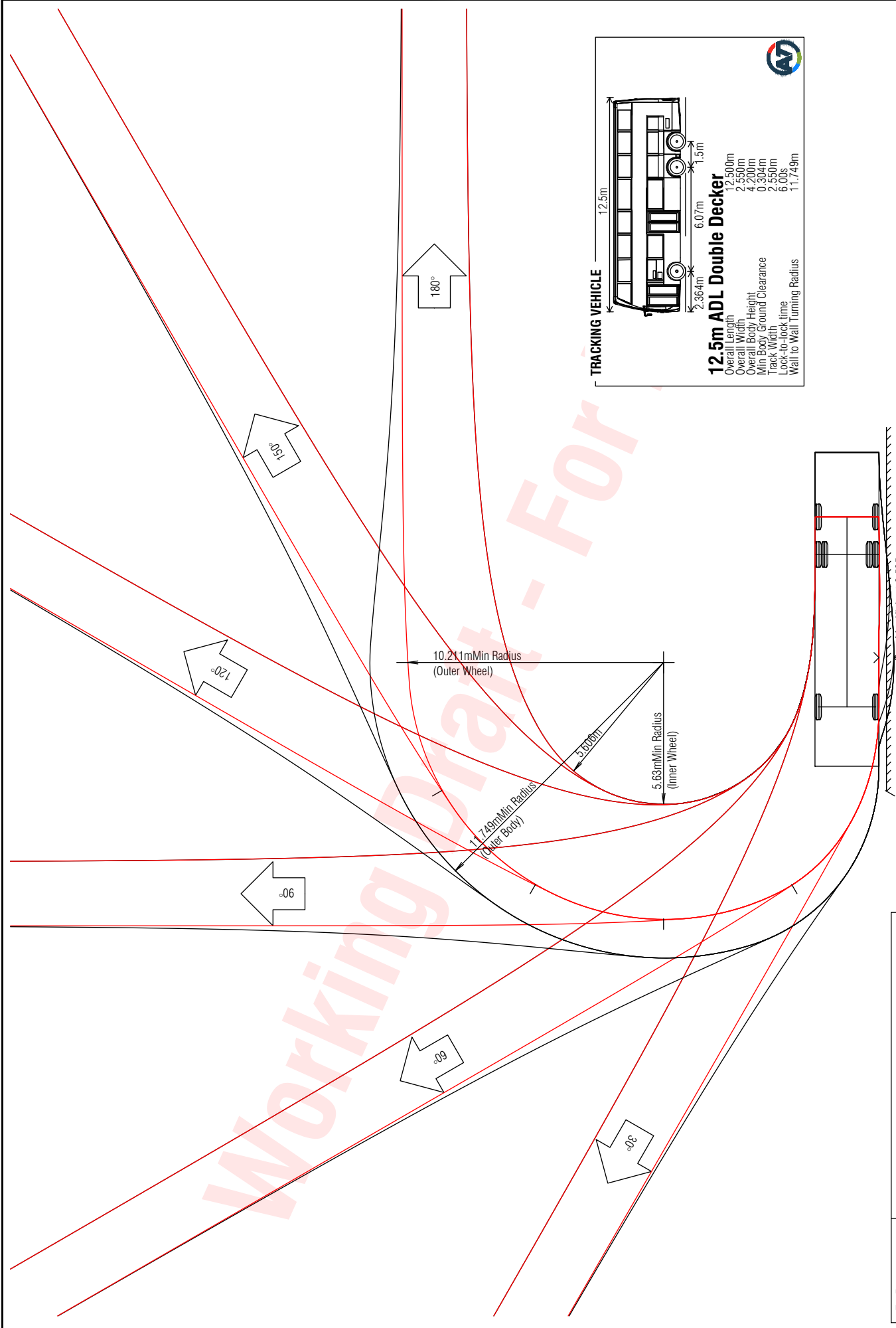

TRACKING VEHICLE

12.5m ADL Double Decker

- Overall Length 12.500m
- Overall Width 2.364m
- Overall Body Height 4.200m
- Min Body Ground Clearance 0.304m
- Track Width 2.550m
- Lock-to-Lock time 6.00s
- Wall to Wall Turning Radius 11.749m



Review 1

DATE: August 8, 2021

TDM TECHNICAL STANDARDS
 AT - Bus - 12.5m Double Decker - ADL

Date: **Document in Review**

SED No. **VT0104** Version **A**

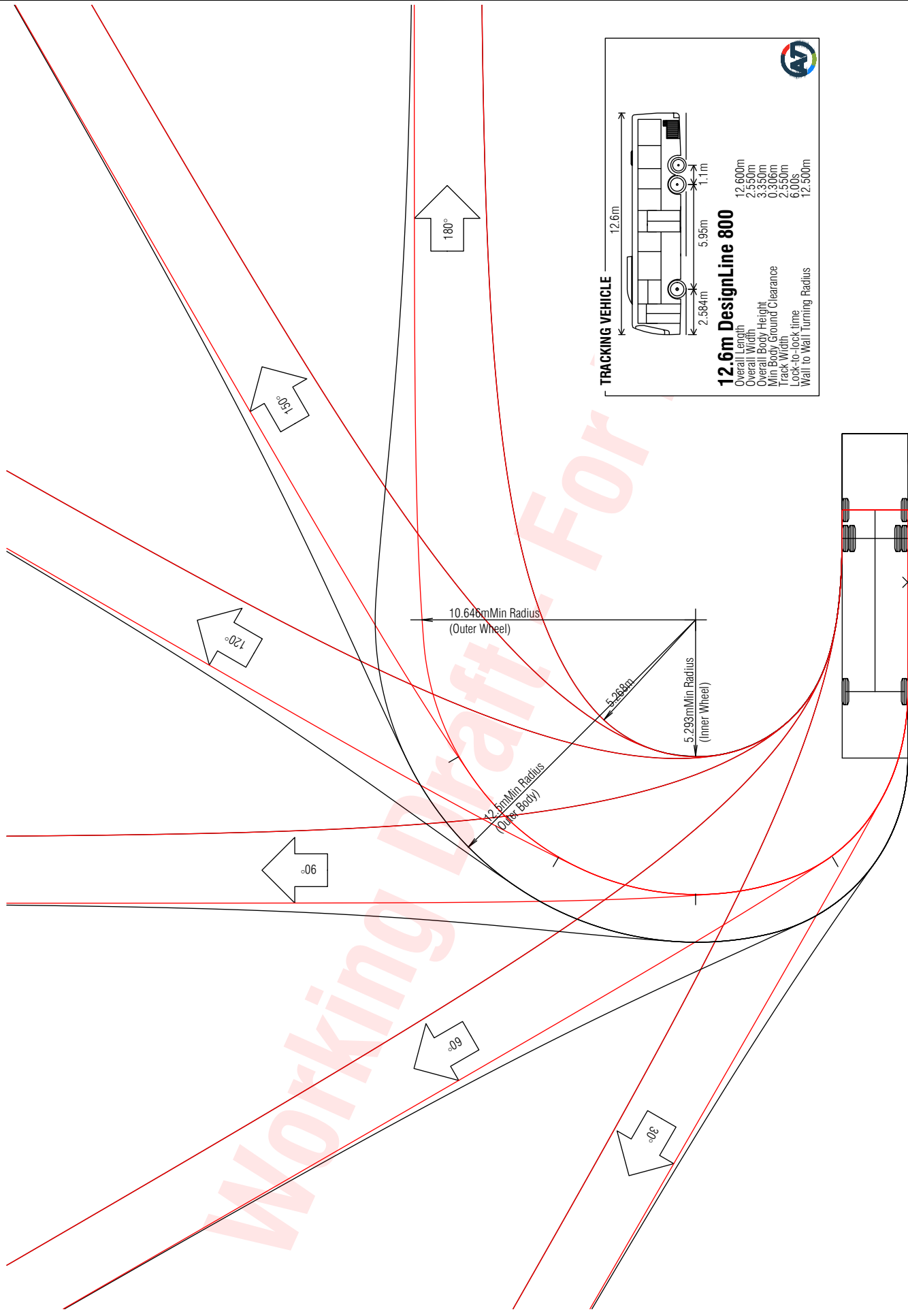

TRACKING VEHICLE

12.6m DesignLine 800

- Overall Length 12.600m
- Overall Width 2.584m
- Overall Body Height 3.350m
- Min Body Ground Clearance 0.306m
- Track Width 2.550m
- Lock-to-lock time 6.00s
- Wall to Wall Turning Radius 12.500m

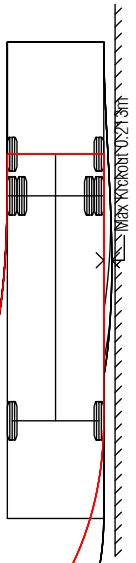

A4 1:200

A3 1:100

Review 1

DATE: August 8, 2021

TDM TECHNICAL STANDARDS

AT - Bus - 12.6m Designline 800

Date: **Document in Review**

SED No. **VT0105** Version **A**

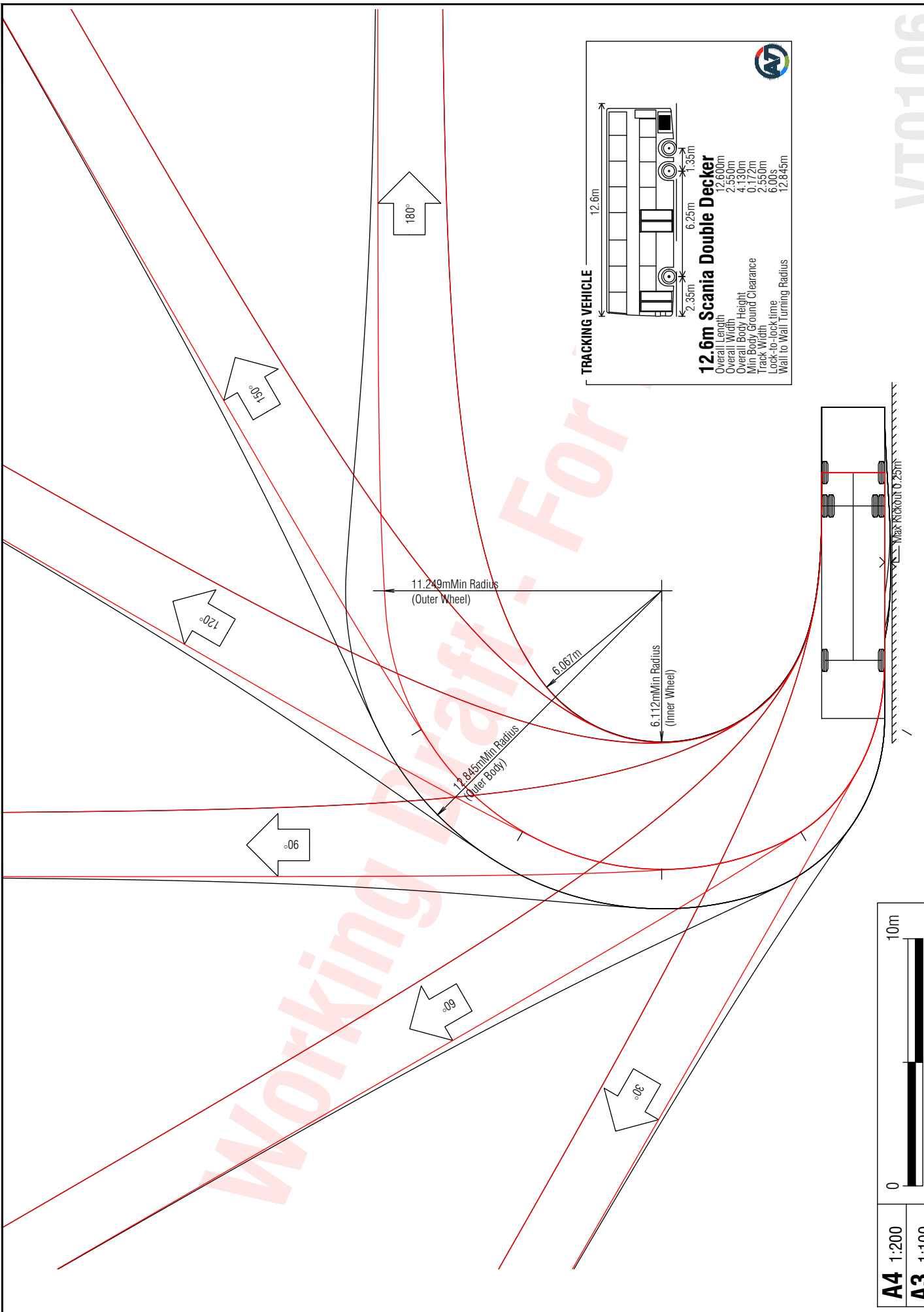

TRACKING VEHICLE

12.6m Scania Double Decker

- Overall Length: 12.600m
- Overall Width: 2.550m
- Min Body Height: 4.130m
- Min Body Ground Clearance: 0.172m
- Track Width: 2.350m
- Lock to Lock Time: 6.00s
- Wall to Wall Turning Radius: 12.845m

A4 1:200

A3 1:100

Review 1

DATE: August 8, 2021

TDM TECHNICAL STANDARDS

AT - Bus - 12.6m Double Decker - Scania

Date: **Document in Review**

SED No. **VT0106** Version **A**

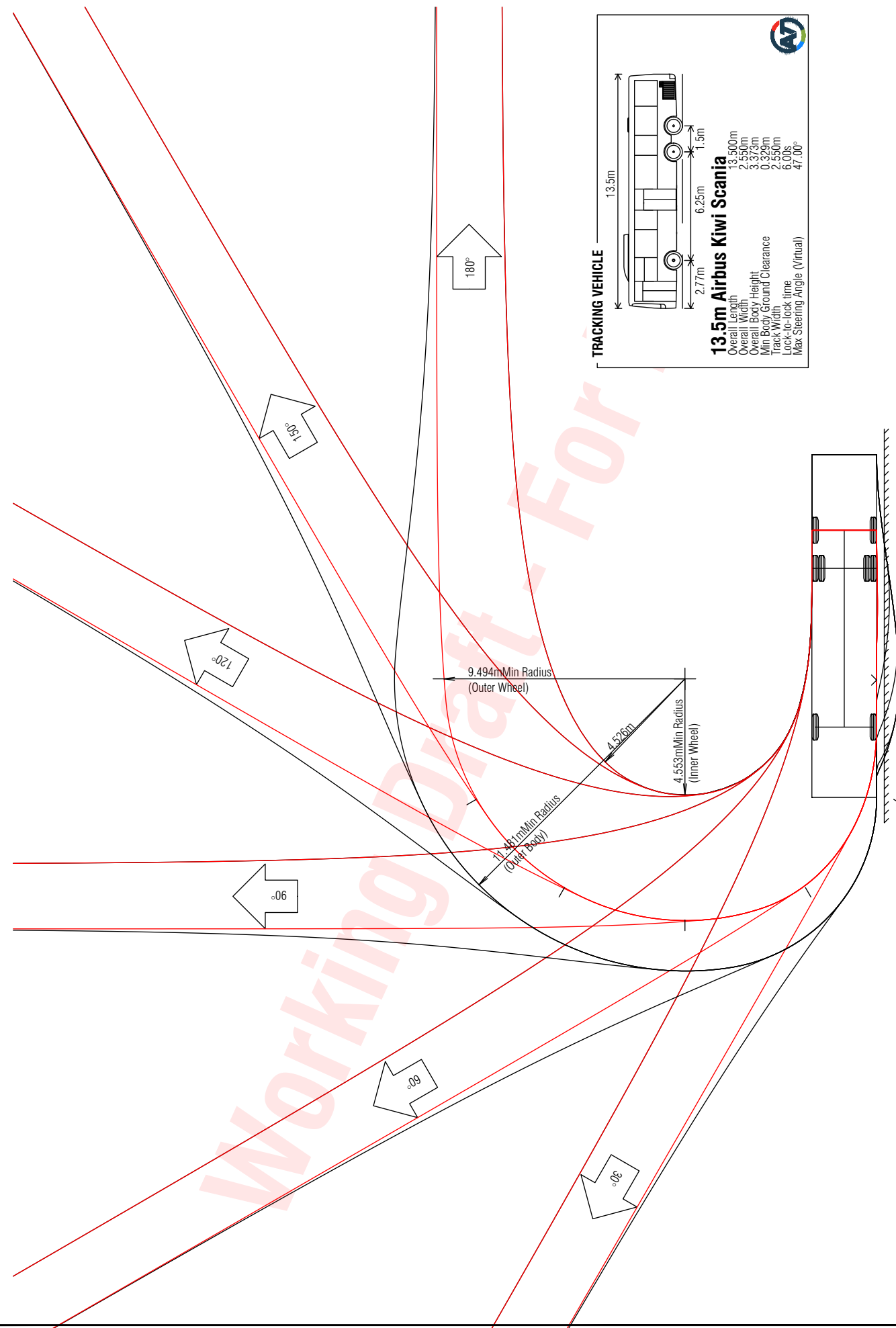

TRACKING VEHICLE

13.5m Airbus Kiwi Scania

Overall Length	13.500m
Overall Width	2.550m
Min Body Height	3.373m
Min Body Ground Clearance	0.329m
Track Width	2.550m
Lock-to-lock time	6.00s
Max Steering Angle (Virtual)	47.00°

A4	1:200	
A3	1:100	

Review 1

DATE: August 8, 2021

TDM TECHNICAL STANDARDS

AT - Bus - 13.5m Airbus Kiwi - Scania

Date: **Document in Review**

SED No.	Version
VT0107	A

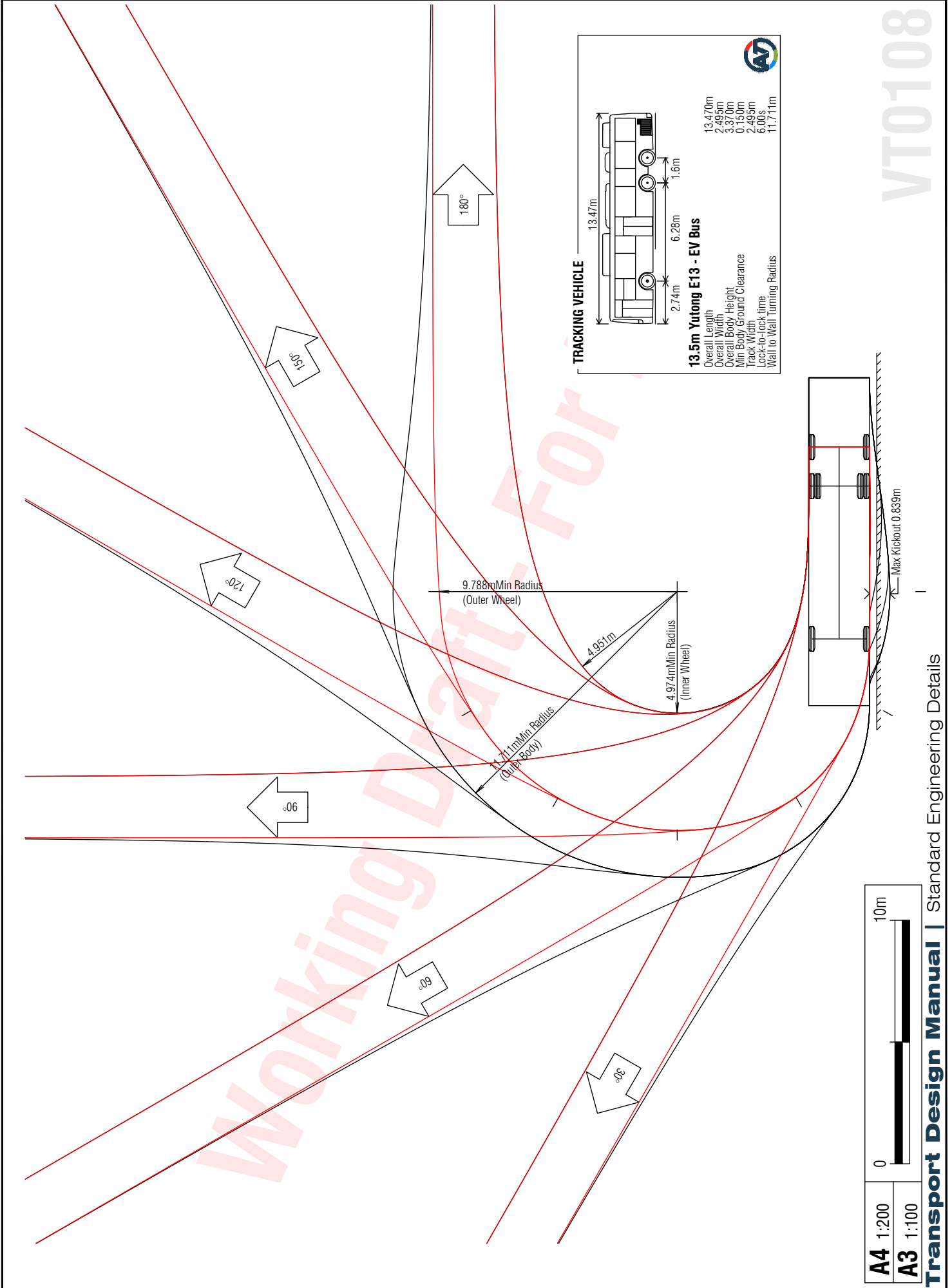

TRACKING VEHICLE

13.5m Yutong E13 - EV Bus

- Overall Length 13.470m
- Overall Width 2.495m
- Overall Body Height 3.370m
- Min Body Ground Clearance 0.150m
- Track Width 2.495m
- Lock-to-lock time 6.00s
- Wall to Wall Turning Radius 11.711m

A4 1:200

A3 1:100

10m

Review 1

DATE: August 8, 2021

TDM TECHNICAL STANDARDS

AT - 13.5m Yutong E13 - EV Bus

Date: **Document in Review**

SED No. **VT0108** Version **A**

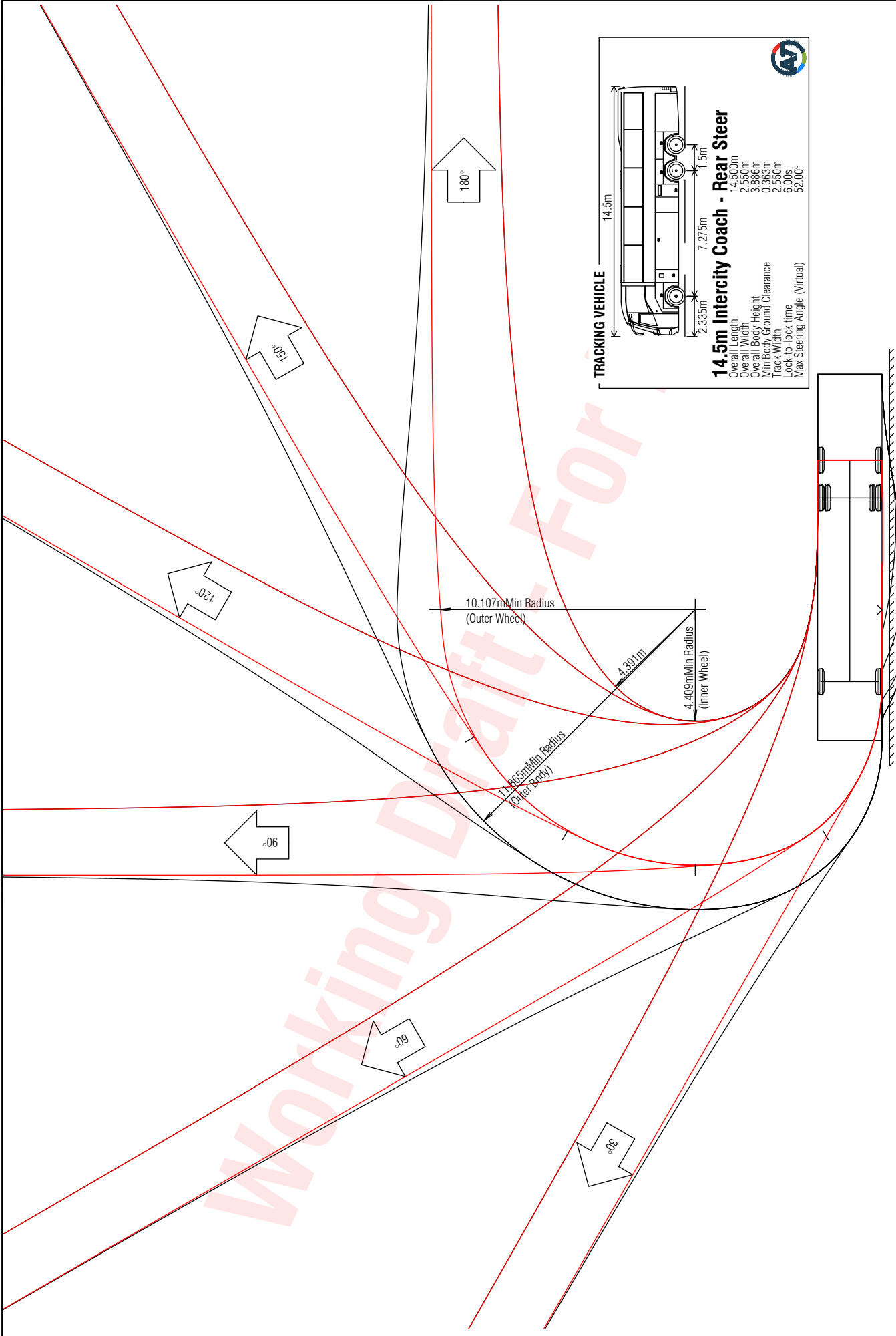

TRACKING VEHICLE

14.5m Intercity Coach - Rear Steer

- Overall Length 14.500m
- Overall Width 2.550m
- Min Body Height 3.886m
- Min Body Ground Clearance 0.363m
- Track Width 2.550m
- Lock-to-lock time 6.00s
- Max Steering Angle (Virtual) 52.00°

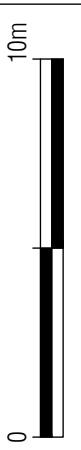

A4 1:200
A3 1:100

Review 1

DATE: August 8, 2021

TDM TECHNICAL STANDARDS
 AT - Bus - 14.5m Intercity

Date: **Document in Review**
 SED No. **VT0109** Version **A**

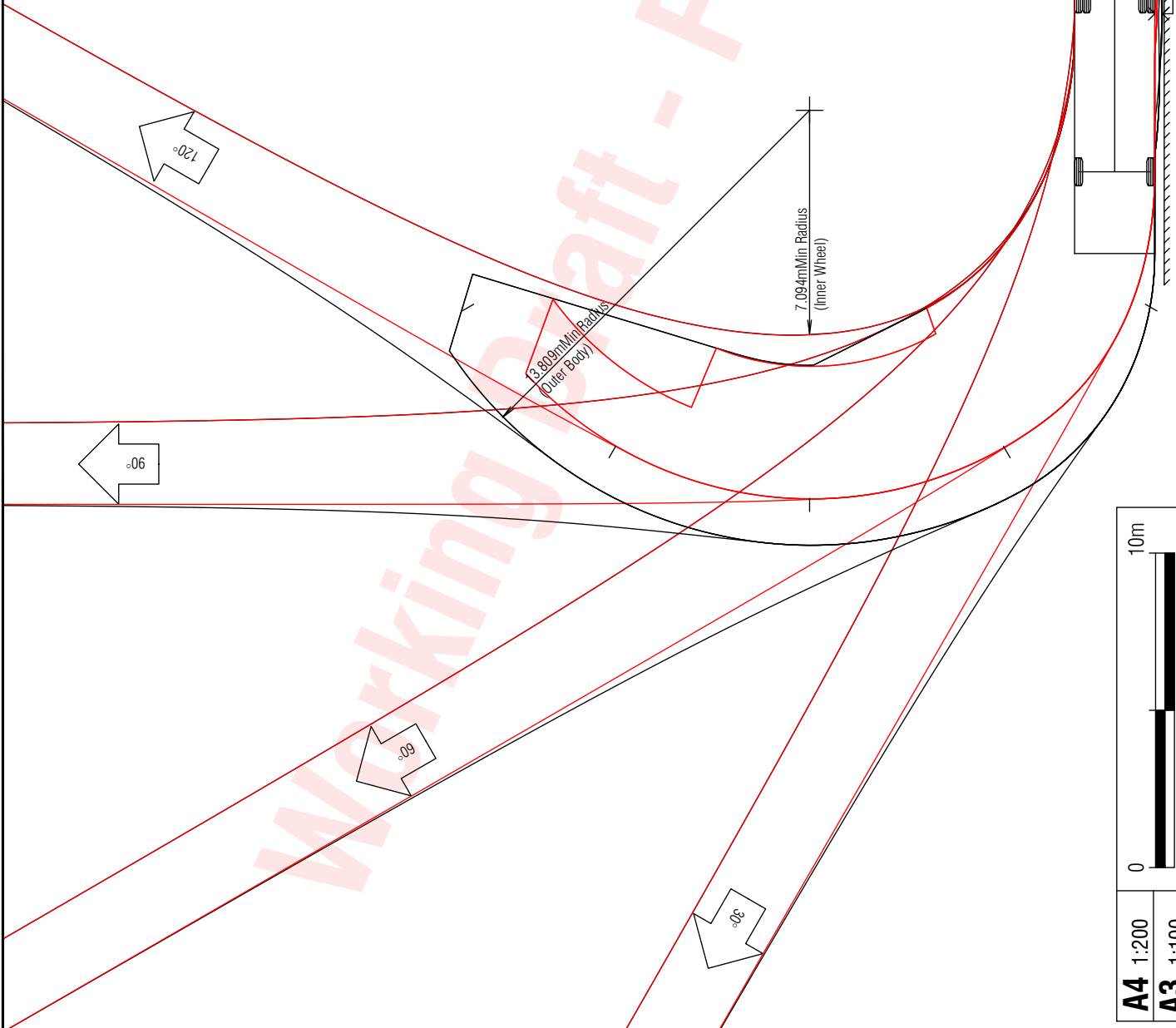

TRACKING VEHICLE

19.0m Articulated Bus

Overall Length	19,000mm
Overall Width	2,550mm
Overall Body Height	3,303mm
Min Body Ground Clearance	0,259mm
Track Width	2,550mm
Lock-to-Lock time	6,00s
Max Steering Angle (Virtual)	33.50°

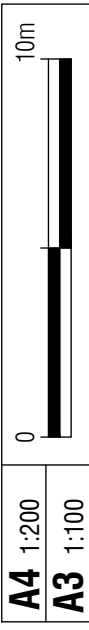
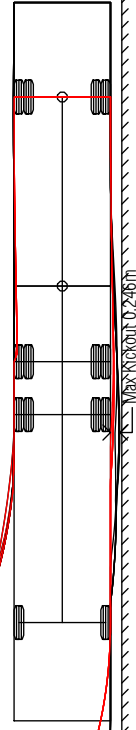

A4 1:200
A3 1:100

Review 1

DATE: August 8, 2021

TDM TECHNICAL STANDARDS
AT - Bus - 19.0m Articulated

Date: **Document in Review**
SED No. **VT0110** Version **A**